

Trouble Shooting Guide Book

[RAC]

CAUTION

Make sure to fully read and understand the safety precautions described in the SVC manual before SVC. Only authorized personnel are allowed to use this service guide.



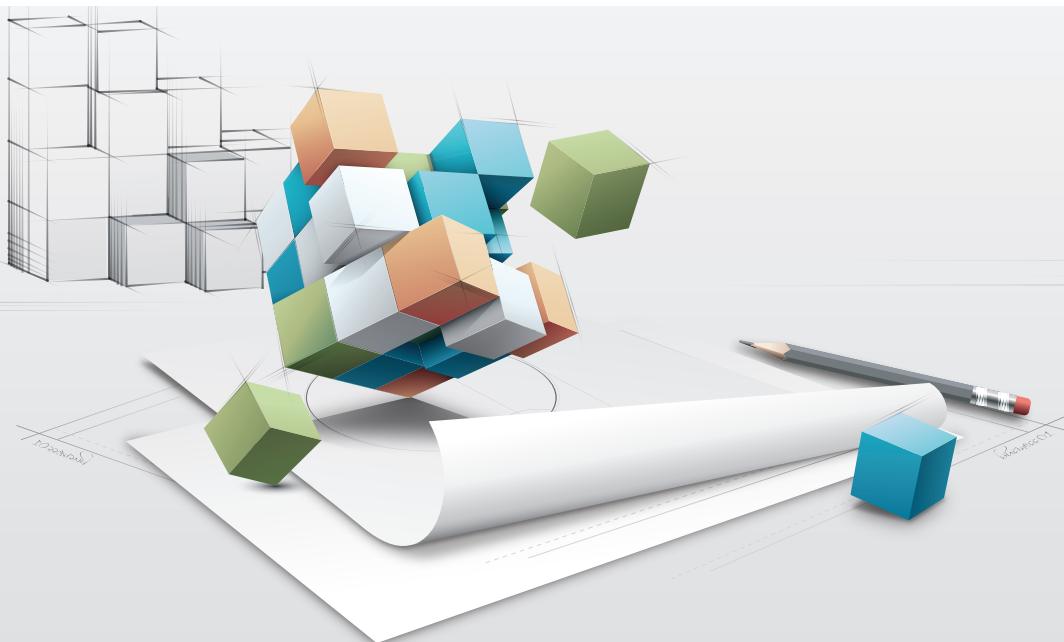

Contents

Trouble Shooting Guide Book

1. Error message

Error Indicator	010
Caution	010
Indoor Unit Error	011
Outdoor Unit Error	013
Descriptions of main symbols	016
Introduction of Guide Form	017

2. T/S Guide (Non-Error Code)

Indoor Unit Leakage	020
No operation of Indoor Unit (Power insensitive)	022
Bad reception & No operation of Wireless Remote Control	023
Weak Air conditioning/Heating	025
Vibration/Resonance noise of Indoor Unit	027
Touch noise of Outdoor Unit	029
Working of circuit breaker during operation	031
Bad operation of AC Fan	033

3. T/S Guide (Error Code)

CH 01 Indoor Unit Room Temp Sensor Open/Short	036
CH 02 Indoor Unit Inlet Pipe Sensor Open/Short	036
CH 06 Indoor Unit Outlet Pipe Sensor Open/Short	036
CH 12 Indoor Unit Middle Pipe Sensor Open/Short	036
CH 03 Bad communication of wired remote control	037
CH 04 Float Switch Error (Optional)	039
CH 05/53/93 Indoor/Outdoor Unit communication Error	040
CH 09 Indoor Unit EEPROM Error	043
CH 10 Indoor BLDC Fan Locking	044
CH 21 High Current Into the Compressor (DC Peak)	045
CH 29 Compressor input Phase Current is High	045
CH 22 AC input Current is Higher than the Limit	047
CH 23 DC Link Voltage Low / High	049
CH 26 DC Compressor Position Error	050
CH 27 PSC Fault Error	051
CH 32 High Temperature in Discharge Pipe of the Inverter Compressor	052
CH 34 High Pressure Sensor Error (High)	054
CH 35 Low Pressure Sensor Error (Low)	054
CH 36/38 Refrigerant Leakage Detection	056
CH 37 Failure Compressing Ratio	057
CH 40 Inverter CT Sensor Open/Short	059
CH 41 Inverter Discharge Sensor Open / Short	060
CH 44 Outdoor Air Temperature Open / Short	060
CH 45/48 Outdoor Unit Pipe Sensor Open / Short	060
CH 46 Compressor Suction Sensor Open / Short	060
CH 42 Low Pressure Sensor Open / Short	061

Trouble Shooting Guide Book

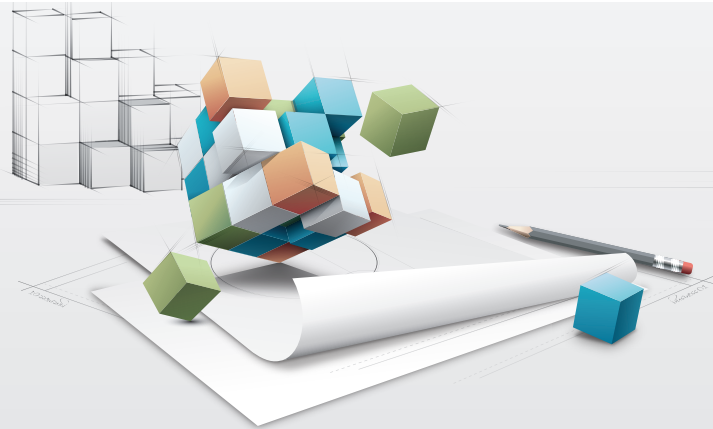

CH 43 High Pressure Sensor Open / Short	061
CH 51 Excessive number of access device with over capacity	062
CH 61 High Temperature in Condenser Pipe	063
CH 62 High Temperature in Outdoor PCBA Heat Sink	065
CH 67 Outdoor BLDC Fan Locking	066
CH 72 Switching for 4 Way Valve is Failed	067

4. Appendix

A Installation Checking

A1 Installation Location	
A1-1 Check Indoor Unit Location	070
A1-2 Check Outdoor Unit Location	072
A2 Piping Work	
A2-1 Check Piping Connection	075
A2-2 Check Welding(Brazing) Work	078
A3 Electric Wiring Work	
A3-1 Check Wire Specification	079
A3-2 Check Wiring Connection	080
A4 Insulation & Drain Work	
A4-1 Standard Insulation Work	083
A4-2 Water Leak Test	085
A5 Vacuum	
A5-1 Gas Leak Test	089
A5-2 Vacuum Work Process	090
A5-3 Additional Charge Refrigerant	092
A6 Test Run	
A6-1 How to Operating	093
A6-2 Check Item	094

B LG SIMs

B1 How to Use LG SIMs 2.0	
B1-1 Specification	098
B1-2 Main Information	099
B1-3 Outdoor Information	102
B1-4 Indoor Information	104
B1-5 Graph (Temp. & Electronic)	105
B2 Basic Checking Guide	
B2-1 Power Apply Check	107
B2-2 Product Operation Check	110
B3 Abnormal Case Guide	

B3-1 No Refrigerant / Defective Sensor	112
B3-2 Cycle Block (EEV, SVC Valve Closed)	113
B3-3 Cycle Block (No Action of EEV) / Bad Location of Td Sensor	114
B4 Reference Cycle Temperature Table	
B4-1 Cooling Mode	115
B4-2 Heating Mode	117

C Electrical Part Checking Method

C1 PCBA	
C1-1 Classification of PCBA Type	120
C1-2 Key Measurement Point for each Type	125
C1-3 Main Fuse	132
C1-4 BLDC Fan Motor Fuse	134
C1-5 SMPS Fuse	135
C1-6 SMPS Circuit Check	136
C1-7 Sensing Unit Circuit Check	143
C1-8 DC-Link Check	150
C1-9 Communication Part 72V Check	151
C1-10 IPM Check	153
C1-11 External Fan IPM Check	155
C1-12 PFCM Check	156
C1-13 Heat-Sink Check	157
C2 Sensor	
C2-1 Air / Pipe Sensor Check	158
C2-2 Pressure Sensor Check	159
C2-3 Indoor / Outdoor Sensor Resistance Table	160
C3 Compressor	
C3-1 Compressor and Pipe Insulation Check	164
C3-2 Compressor Line Resistance Check	164
C4 Motor	
C4-1 BLDC Motor	165
C4-2 AC Motor	166
C4-3 External Fan Motor	167
C5 4 Way Valve	168
C6 EEV	169
C7 Etc.	
C7-1 Sump-Heater	170
C7-2 Reactor Connection	171
C7-3 Communication Line	172
C7-4 Main & Terminal Line, Compressor Harness	173

1. Error message

1. Error message

■ Error Indicator

- The function is to self-diagnosis air conditioner and express the troubles identically if there is any trouble.
- If more than two troubles occur simultaneously, primarily the highest trouble of error code is expressed.
- After error occurrence, if error is released, error LED is also released simultaneously.
- To operate again on the occurrence of error code, be sure to turn off the power and then turn on.
- Having or not of error code is different from Model.

■ Caution

- CH01~12 are related to the indoor unit problems, and CH21~73 are related to the outdoor unit problems except CH05/53. Do not replace the indoor unit parts based on CH21~73 errors except CH53, or replace the outdoor unit parts based on CH01~12 errors except CH05.
- Main errors among the outdoor unit errors will display in the indoor unit only when they are detected 10 times per hour. Therefore the type of errors can be identified from LED on the outdoor unit PCBA even before it is displayed in the indoor unit. Check for the LED on the outdoor unit PCBA.
- After removing the cause of CH error, turn power off and on after 3 minutes, and then Display indicator will disappear from the outdoor unit PCBA or indoor unit. It requires 3 minutes to fully discharge the outdoor unit PCBA.

■ Indoor Unit Error

Error Code	Descriptions	Number of flashes	
		Indoor unit	
		LED 1	LED 2
01	Indoor unit room temperature sensor error	1 time	-
02	Indoor unit inlet pipe sensor error	2 times	-
03	Wired remote control error	3 times	-
04	Float switch error(optional)	4 times	-
05	Communication error between indoor & outdoor units	5 times	-
06	Indoor unit outlet pipe sensor error	6 times	-
09	Indoor unit EEPROM error	9 times	-
10	Indoor unit BLDC motor fan lock	-	1 time
12	Indoor unit middle pipe sensor error	2 times	1 time

1) Type 1 (2 LED)
- SW, SB, SC Chassis

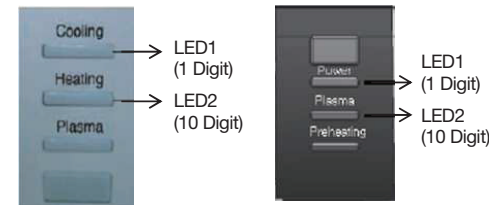

2) Type 2 (Horizontal 4 LED)
- S4, S5 Chassis

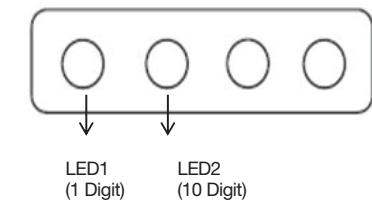

3) Type 3
- SH Chassis



4) Type 4 (vertical 3 or 4 LED)
- SA, SJ Chassis

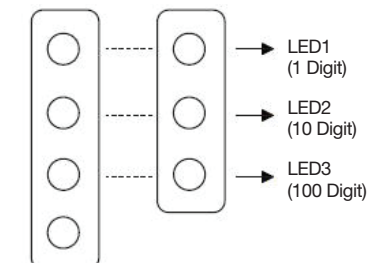

1. Error message

5) Type 5 (Number Display Model)



Ex) Error Code CH05

6) Type 6 (1 LED)

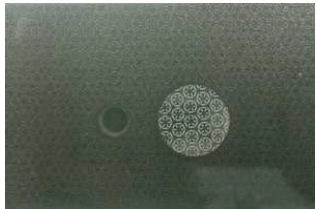

Ex) Error Code CH02

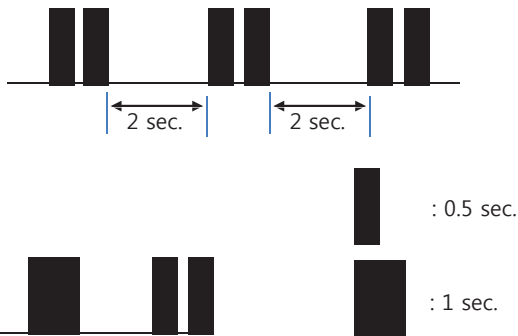

Ex) Error Code CH12

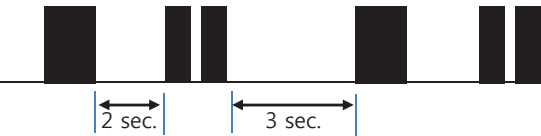

7) Type 7 (Gallery)

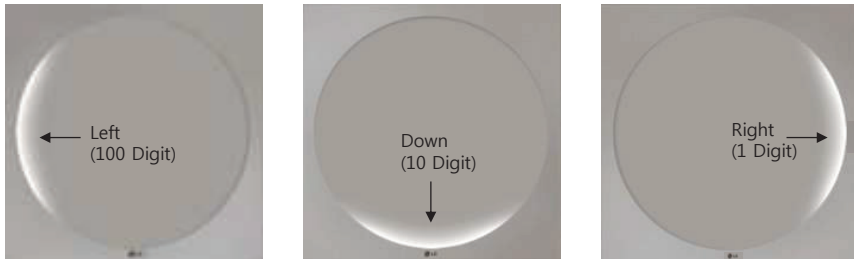

Outdoor Unit Error

1) 2 LED Type

Error Code	Description	Error Indication	
		In/Outdoor	
		LED 2	LED 1
21	DC Peak (IPM Fault)	2 Times	1 Time
22	CT 2 (Max CT)	2 Times	2 Times
23	DC Link Low Volt	2 Times	3 Times
26	DC Comp Position Error	2 Times	6 Times
27	PSC Fault	2 Times	7 Times
29	Comp Phase Over-Current	2 Times	9 Times
32	Inverter Compressor D-Pipe Overheat	3 Times	2 Times
34	High Pressure Sensor High	3 Times	4 Times
35	Low Pressure Sensor Low	3 Times	5 Times
36/38	Refrigerant Leakage Detection	3 Times	6/8 Times
37	Exceed the Compression Ratio Limit	3 Times	7 Times
40	CT Sensor Error	4 Times	-
41	D-Pipe Sensor Error	4 Times	1 Times
42	Low Pressure sensor Error	4 Times	2 Times
43	High Pressure sensor Error	4 Times	3 Times
44	Outdoor Air Sensor Error	4 Times	4 Times
45	Cond. Middle Pipe Sensor Error	4 Times	5 Times
46	S-Pipe Sensor Error	4 Times	6 Times
51	Excess Capacity (Mismatching between In/Outdoor unit)	5 Times	1 Times
53	Communication Error (IN-OUT)	5 Times	3 Times
61	Cond. Pipe High	6 Times	1 Times
62	Heat Sink Sensor Temp. High	6 Times	2 Times
67	BLDC Motor Fan Lock	6 Times	7 Times
72	Detect 4 Way Valve Transfer Failure	7 Times	2 Times
93	Communication Error (IN-OUT)	9 Times	3 Times

1. Error message

2) 1 LED Type

Error Code	Description	Error Indication			
		Outdoor Unit		Indoor Unit	
		Red	Red	LED 2	LED 1
21	DC Peak (IPM Fault)	2 Times	1 Time	2 Times	1 Time
22	CT 2 (Max CT)	2 Times	2 Times	2 Times	2 Times
23	DC Link Low Volt	2 Times	3 Times	2 Times	3 Times
26	DC Comp Position Error	2 Times	6 Times	2 Times	6 Times
27	PSC Fault	2 Times	7 Times	2 Times	7 Times
29	Comp Phase Over-Current	2 Times	9 Times	2 Times	9 Times
32	Inverter Compressor D-Pipe Overheat	3 Times	2 Times	3 Times	2 Times
34	High Pressure Sensor High	3 Times	4 Times	3 Times	4 Times
35	Low Pressure Sensor Low	3 Times	5 Times	3 Times	5 Times
36/38	Refrigerant Leakage Detection	3 Times	6/8 Times	3 Times	6/8 Times
37	Exceed the Compression Ratio Limit	3 Times	7 Times	3 Times	7 Times
40	CT Sensor Error	4 Times	-	4 Times	-
41	D-Pipe Sensor Error	4 Times	1 Times	4 Times	1 Times
42	Low Pressure sensor Error	4 Times	2 Times	4 Times	2 Times
43	High Pressure sensor Error	4 Times	3 Times	4 Times	3 Times
44	Outdoor Air Sensor Error	4 Times	4 Times	4 Times	4 Times
45	Cond. Middle Pipe Sensor Error	4 Times	5 Times	4 Times	5 Times
46	S-Pipe Sensor Error	4 Times	6 Times	4 Times	6 Times
51	Excess Capacity (Mismatching between In/Outdoor unit)	5 Times	1 Times	5 Times	1 Times
53	Communication Error (IN-OUT)	5 Times	3 Times	5 Times	3 Times
61	Cond. Pipe High	6 Times	1 Times	6 Times	1 Times
62	Heat Sink Sensor Temp. High	6 Times	2 Times	6 Times	2 Times
67	BLDC Motor Fan Lock	6 Times	7 Times	6 Times	7 Times
72	Detect 4 Way Valve Transfer Failure	7 Times	2 Times	7 Times	2 Times
93	Communication Error (IN-OUT)	9 Times	3 Times	9 Times	3 Times

3) How they display in the outdoor unit PCBA, 2 LED Model

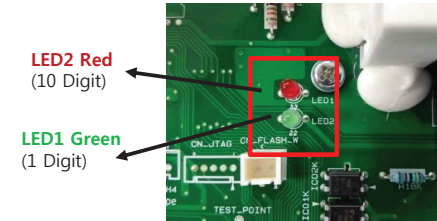

Ex) Error Code CH21

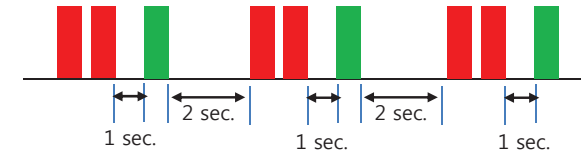

4) How they display in the outdoor unit PCBA, 1 LED Model

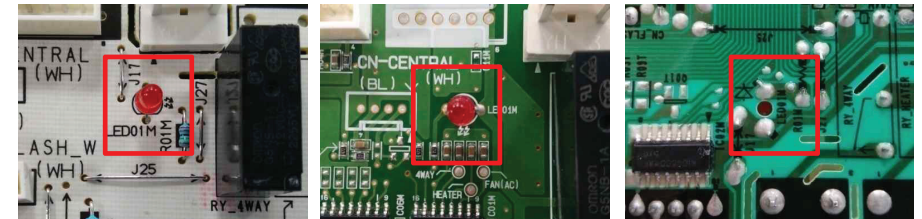

Ex) Error Code CH21

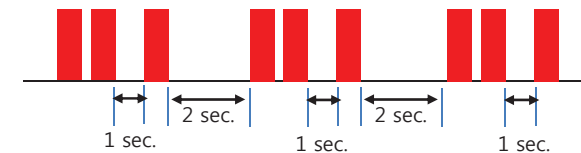

1. Error message

■ Descriptions of main symbols



- It means execution :
- Executes orders in the square box.

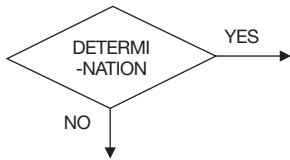

- It means determination :
- Selects YES if correct, NO if incorrect.



- It means solution :
- Executes orders in the square box.



- It means PCBA check :
- It is stage to check PCBA fault when replacing PCBA
- Check when the judgment of PCBA fault is not sure



- It means SIMs module utilization is available:
- Utilize SIMs module to save the test time and convenience
- Easy to collect information for Cycle / Enables judgment for the faulty



- It means Simple Checking Guide



- This symbol indicates the possibility of death or serious injury!



- Dangerous Voltage! Be careful!



- Additional Information

■ Introduction of Guide Form

Error Code	Error Detection	Cause of Error	Check Point
CH 00 It displays an error code.	It displays the description for the error code.	· It describes the cause of error code.	· It describes the details to be confirmed when error code occurs.



Warning It describes the specific considerations before the service for the product. Be sure to perform the service after confirming the warning.



It is a item available for inspection through LG SIMs.

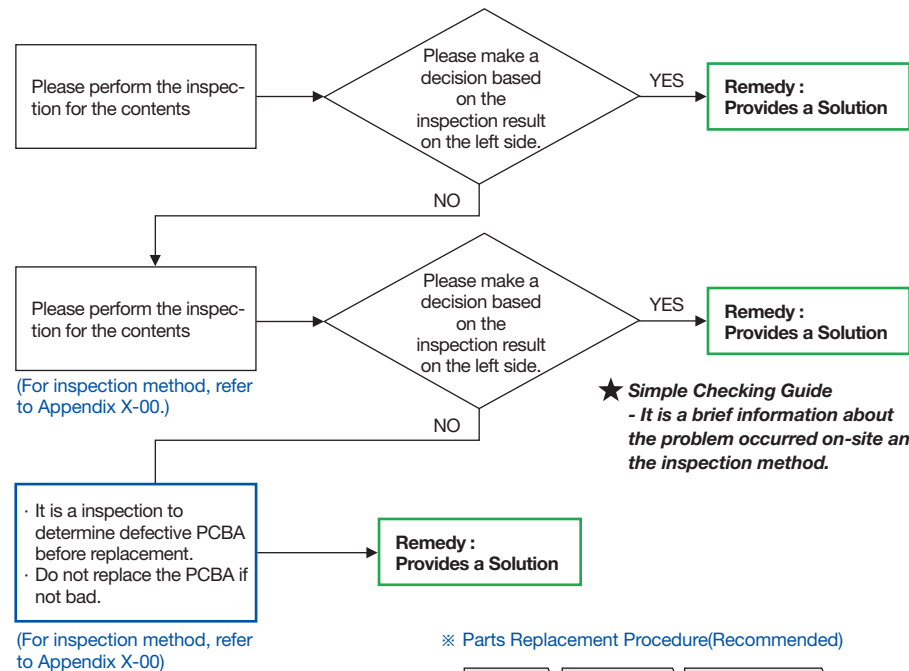

※ Parts Replacement Procedure(Recommended)

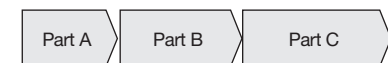

.It is a order to recommend when replacement of the components is need during service

2.T/S Guide (Non-Error Code)

2. T/S Guide (Non-Error Code)

Indoor Unit Leakage

Symptoms	Cause of symptoms	Check Point
<ul style="list-style-type: none"> Leakage of indoor unit 	<ul style="list-style-type: none"> Drain hose installation defects Clogged with debris inside of the drain hose Bad horizontal installation of the product Bad wiring clean-up Heat exchanger contamination Damaged drain pan 	<ul style="list-style-type: none"> Check the status of Drain hose Installation Check debris in the Drain hose Check horizontal status of the Indoor unit Check inner wiring of the Indoor unit Check status of the Indoor unit heat exchanger Check status of the Indoor unit Drain pan



Warning Be sure to prevent condensate from flowing into the electronic units when perform leak test. Be sure to cut off the main power when performing leak test. After completing leak test, confirm the status of inflow of the condensate to the electronic units, and apply power after drying the electronic units perfectly by dryer, etc.

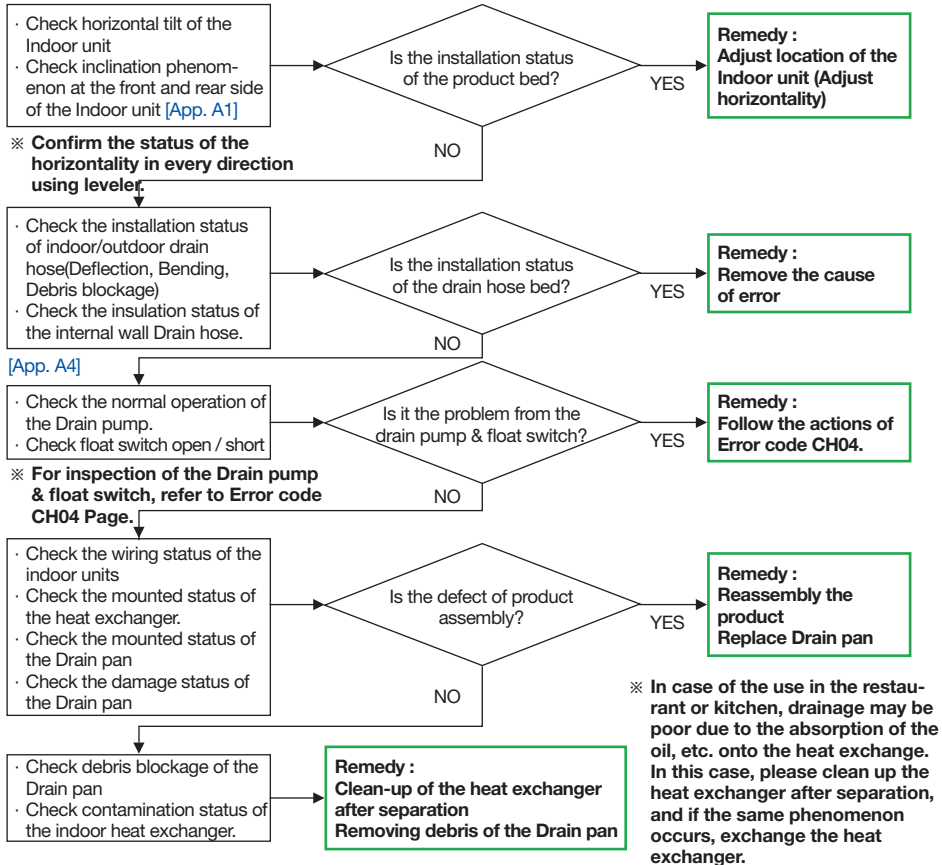

Field failure examples

- Bad installation status of the Indoor unit (tilted)

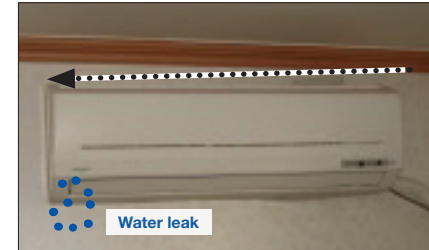

- Bad insulation status of the Drain hose



- Leakage at the outlet of the Indoor unit

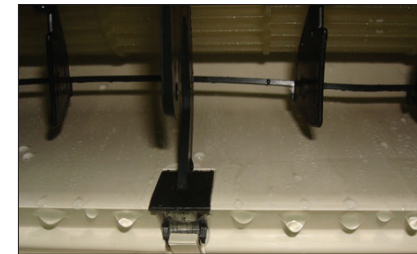

- Oil stain absorption of the Heat exchanger

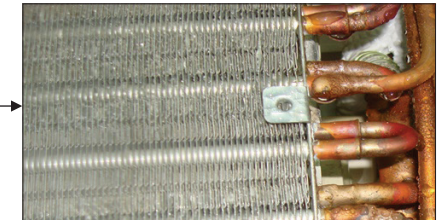

- Shield of Heat exchanger by debris blockage



- Bad wiring status of the Indoor unit

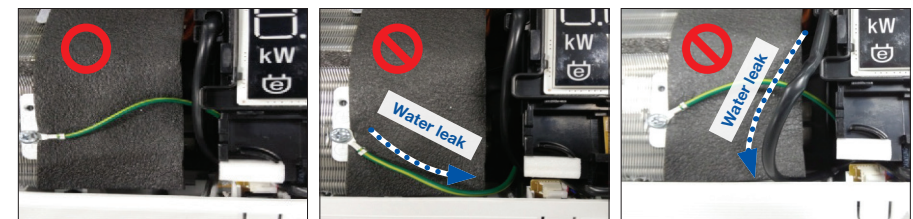

2. T/S Guide (Non-Error Code)

■ No operation of Indoor Unit (Power insensitive)

Symptoms	Cause of symptoms	Check Point
No operation of the indoor unit (Power insensitive)	<ul style="list-style-type: none"> No power applied on the wall Power strip (multi plug outlet) used Bad Main power line Bad connecting wire Outdoor terminal block fuse open Indoor unit PCBA burn-out 	<ul style="list-style-type: none"> Check whether Power strip was used Check wiring connection / main power line open short Check outdoor terminal block fuse Check Indoor unit PCBA burnout



Warning

Before checking PCBA or each outdoor/indoor electric parts, wait for 3 minutes after the power is off.
When measuring at standby state of power supply, after checking the measurement mode of the meter, be careful of the short-circuits with other parts.

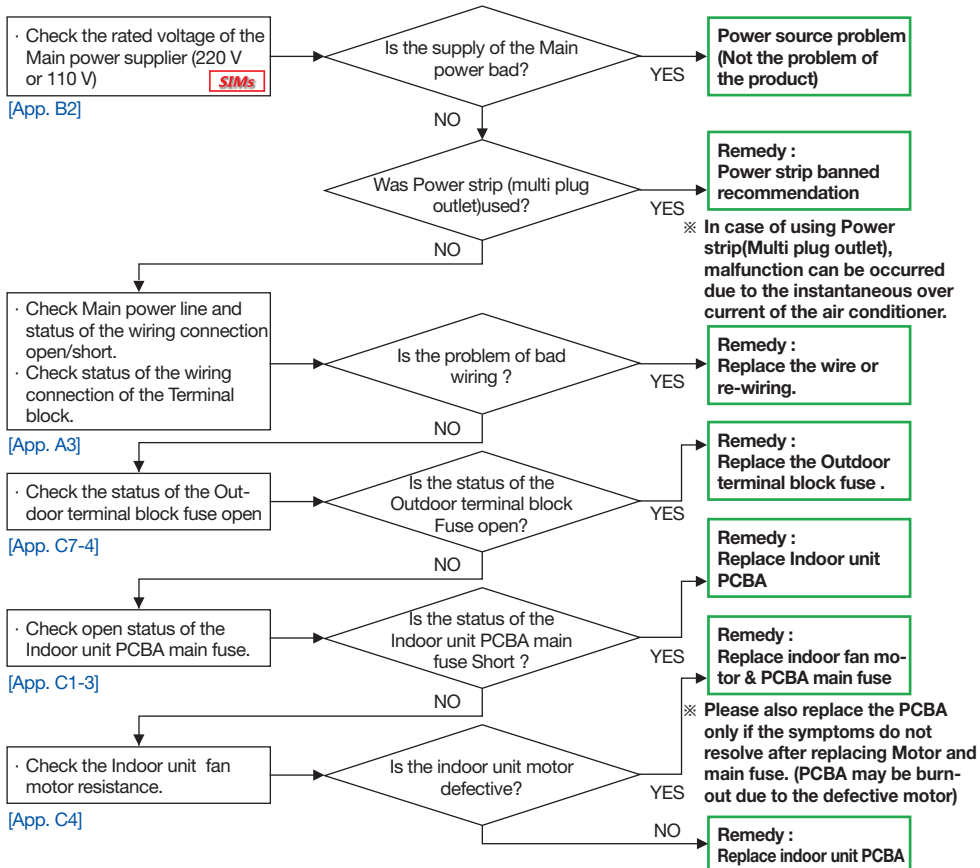

■ Bad reception & No operation of Wireless Remote Control

Symptoms	Cause of symptoms	Check Point
Bad reception of the wireless remote control and no operation	<ul style="list-style-type: none"> Low battery voltage of the remote control Bad Remote control Interference of three-wavelength lamp Bad Display PCBA Bad PCBA wiring Bad Knob switch Bad PCBA 	<ul style="list-style-type: none"> Replace the battery of the remote control Check the defect of the remote control Check Display PCBA wiring Check the defect of the Display PCBA Check wiring of the Knob switch Check the defect of the Knob switch Check the defect of the PCBA.



Warning

Before checking PCBA or each outdoor/indoor electric parts, wait for 3 minutes after the power is off.
When measuring at standby state of power supply, after checking the measurement mode of the meter, be careful of the short-circuits with other parts.

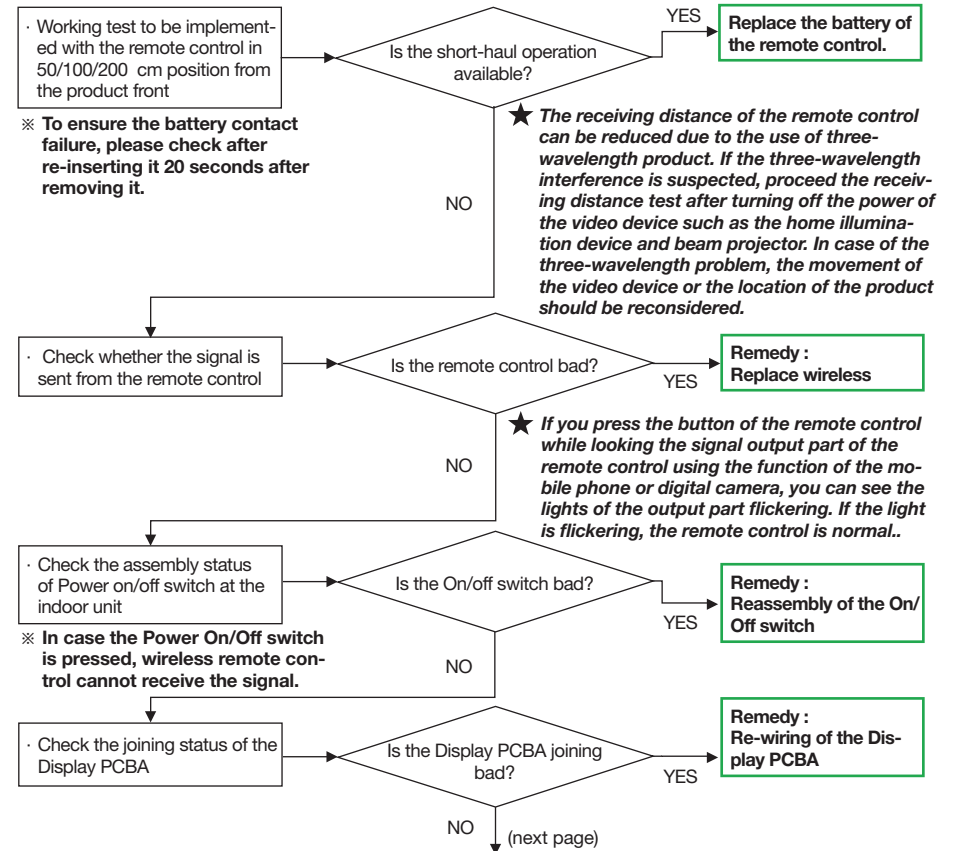

2. T/S Guide (Non-Error Code)

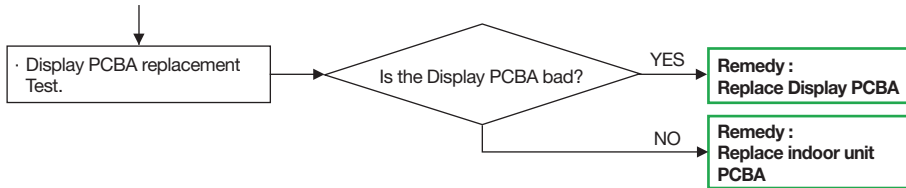

Simple Wireless remote control test

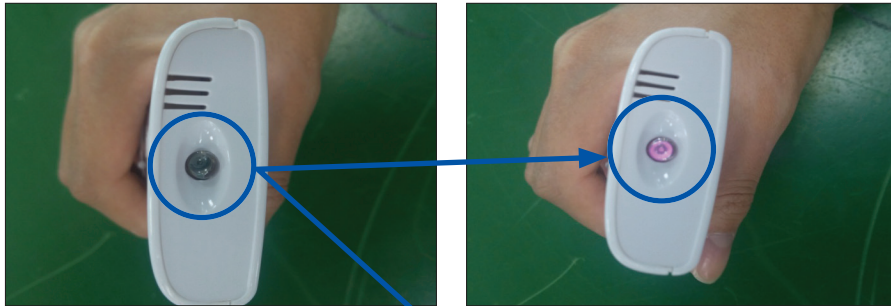

★ In case of the normal product, if you press the button while taking a photograph using the camera function of the mobile phone or digital camera, you can confirm the light of the output part.

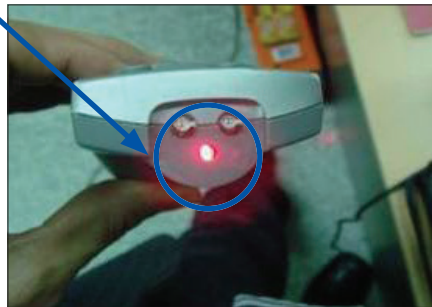

■ Weak Air conditioning/Heating

Symptoms	Cause of symptoms	Check Point
Weak Air-conditioning/ Heating	<ul style="list-style-type: none"> · Bad installation status · Bad characteristics of the Indoor / outdoor unit temperature sensor · Refrigerant leakage · EEV insert defect / Blockage · Refrigerant shortage 	<ul style="list-style-type: none"> · Check the status of the product installation · Check the resistance of the Indoor / outdoor unit temperature sensor · Check symptom of the refrigerant leakage · Check the status of the EEV · Check the quantity of the refrigerant



Warning

Before checking PCBA or each outdoor/indoor electric parts, wait for 3 minutes after the power is off.
When measuring at standby state of power supply, after checking the measurement mode of the meter, be careful of the short-circuits with other parts.

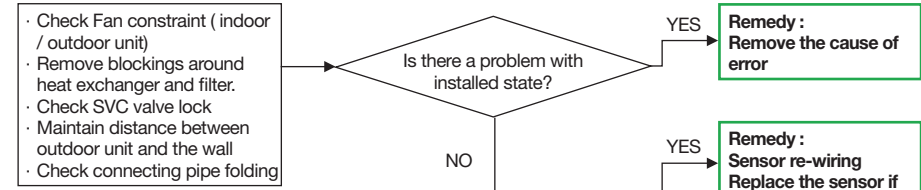

★ In case of the weak air-conditioning / heating due to the sensor error, the bad phenomenon can be identified with reference to the temperature value read from the sensor, utilizing MV before disassembly of the product.
※ There may not be Pipe In/Out Sensor depending on the product, so proceed the service with reference to the SCV Manual.

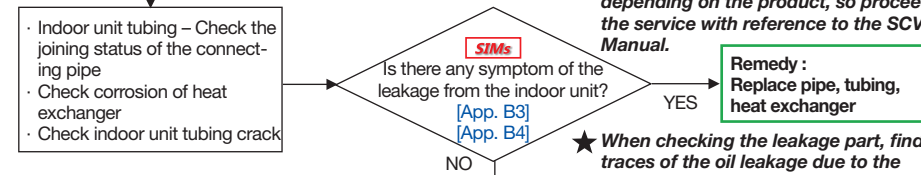

★ When checking the leakage part, find traces of the oil leakage due to the leakage of the gas.

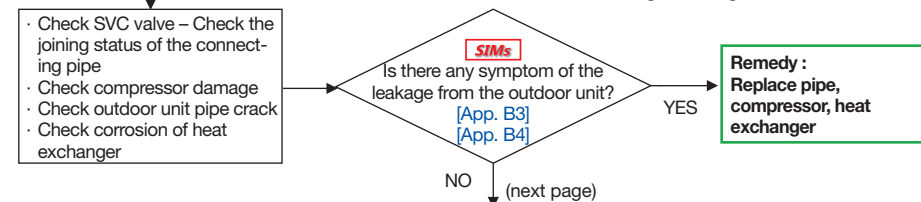

2. T/S Guide (Non-Error Code)

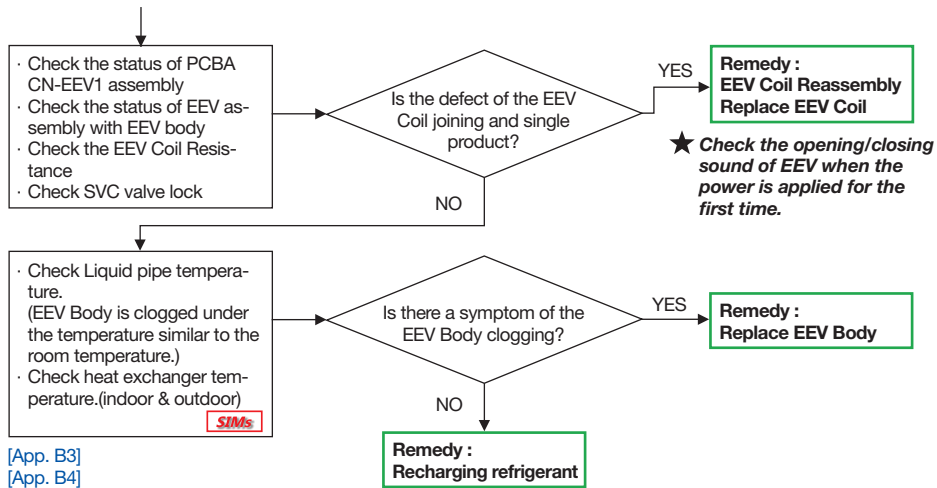

[App. B3]
[App. B4]

Field failure examples

- Airflow is blocked

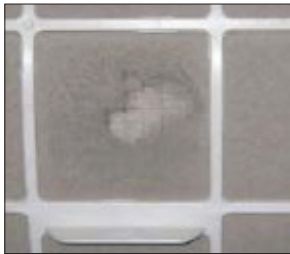

- Service valve closed

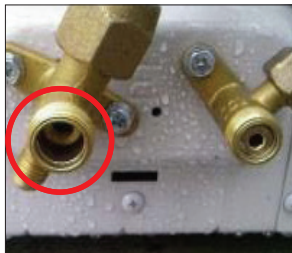

- Interference of the discharge air



- Pipe break



Vibration/Resonance noise of Indoor Unit

Symptoms	Cause of symptoms	Check Point
Indoor unit vibration/ Resonant noise	<ul style="list-style-type: none"> Bad assembly Non-fastening of bolt Parts interference of the exterior movement Pipe bending Non-compliance of the minimum pipe length Refrigerant overcharge 	<ul style="list-style-type: none"> Check the assembly status of the indoor unit. Check bolt fastening status. Check interference during operation of the exterior items (Louver/Vane) Check pipe break. Check pipe length. Check Refrigerant quantity



Warning

Before checking PCBA or each outdoor/indoor electric parts, wait for 3 minutes after the power is off.
When measuring at standby state of power supply, after checking the measurement mode of the meter, be careful of the short-circuits with other parts.

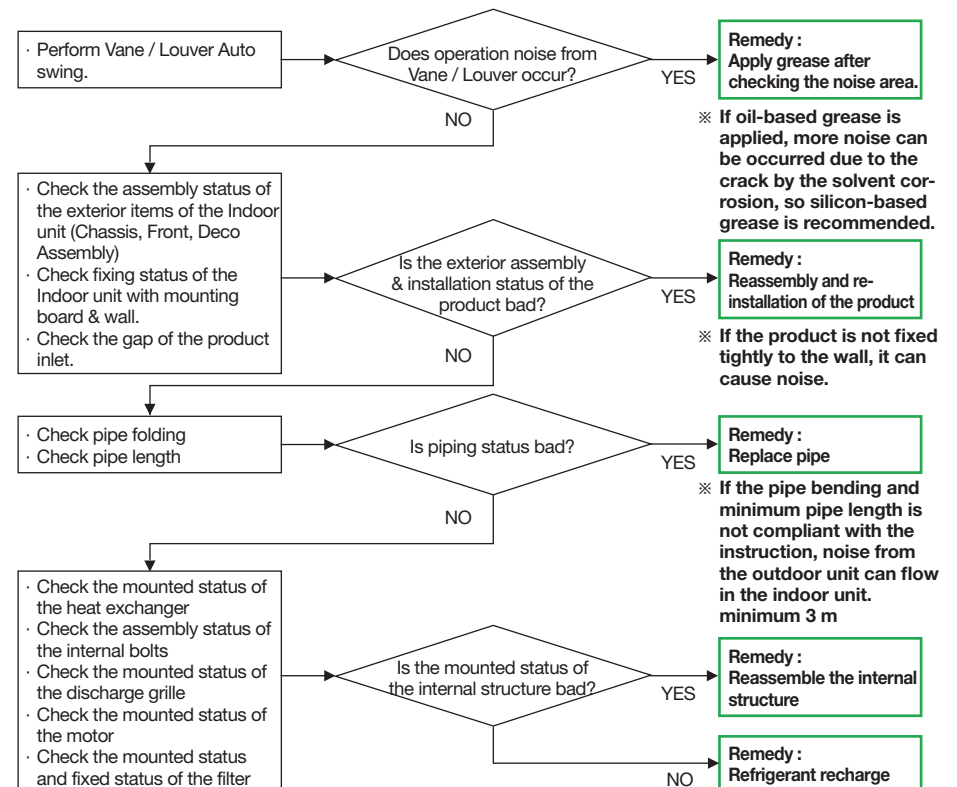

2. T/S Guide (Non-Error Code)

Field failure examples

- Noise occurrence due to the pipe break



- Noise occurrence due to the inlet shield

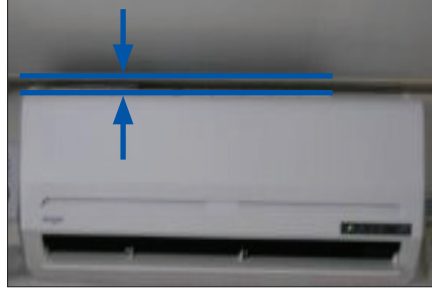

- Noise inflow of the outdoor unit due to the bad pipe length

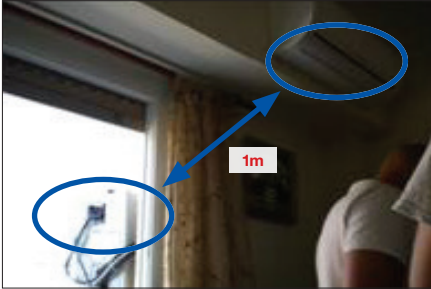

■ Touch noise of Outdoor Unit

Symptoms	Cause of symptoms	Check Point
Outdoor unit touch noise (vibration)	<ul style="list-style-type: none"> · Bad bolt fastening · Interference between Pipe and Front/Side panel · Touch interference between pipes · Debris flow in the inside of the machine room of the outdoor unit 	<ul style="list-style-type: none"> · Check bolt assembly status · Check interference status of the pipe and the exterior items. · Check the separation distance between the pipes · Check the existence of foreign objects inside the machine room

Warning Before checking PCBA or each outdoor/indoor electric parts, wait for 3 minutes after the power is off.
When measuring at standby state of power supply, after checking the measurement mode of the meter, be careful of the short-circuits with other parts.

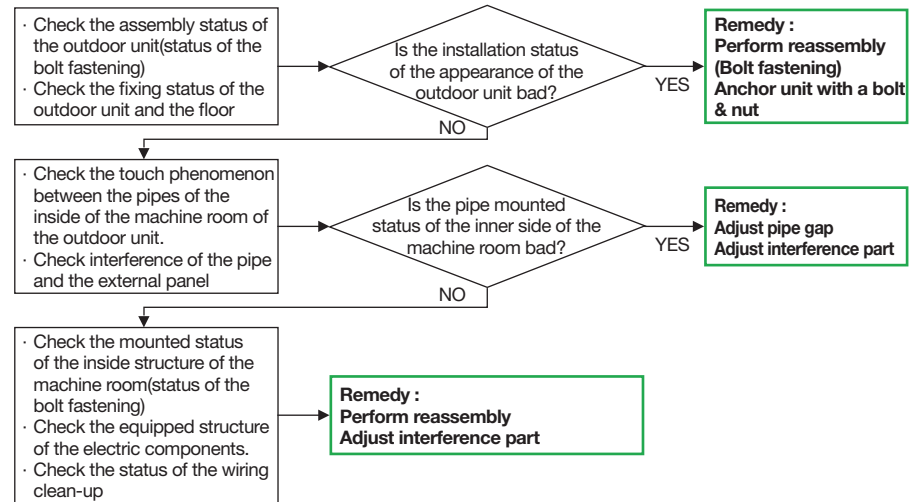

Field failure examples



2. T/S Guide (Non-Error Code)

- Occurrence of the vibration noise caused by the interference of the front panel and the pipe



- Occurrence of the vibration noise caused by the bad fixing of the outdoor unit



■ Working of circuit breaker during operation

Symptoms	Cause of symptoms	Check Point
Working of the circuit breaker during operation	<ul style="list-style-type: none"> · Using multi plug outlet · Shortage of the circuit breaker capacity · Bad sensor · Bad Fan motor · Current leakage of the compressor 	<ul style="list-style-type: none"> · Main power check · Circuit breaker capacity check · Electric parts leakage current check

Warning Before checking PCBA or each outdoor/indoor electric parts, wait for 3 minutes after the power is off.
When measuring at standby state of power supply, after checking the measurement mode of the meter, be careful of the short-circuits with other parts.

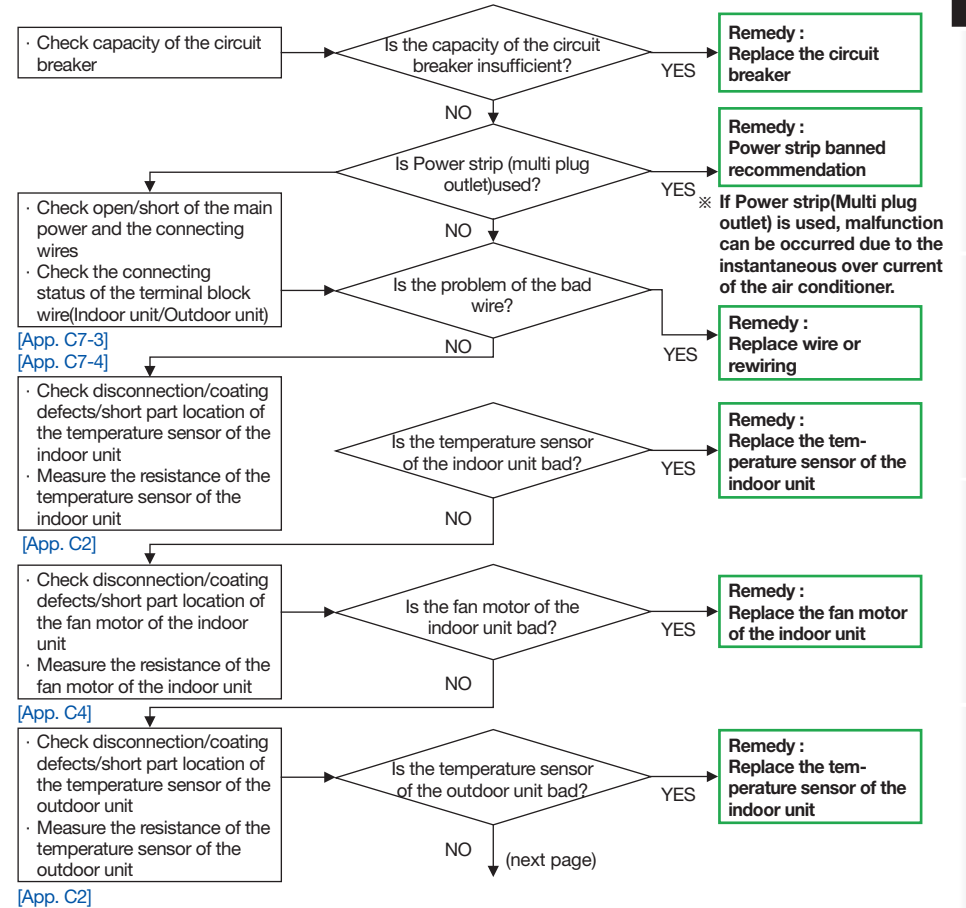

2. T/S Guide (Non-Error Code)

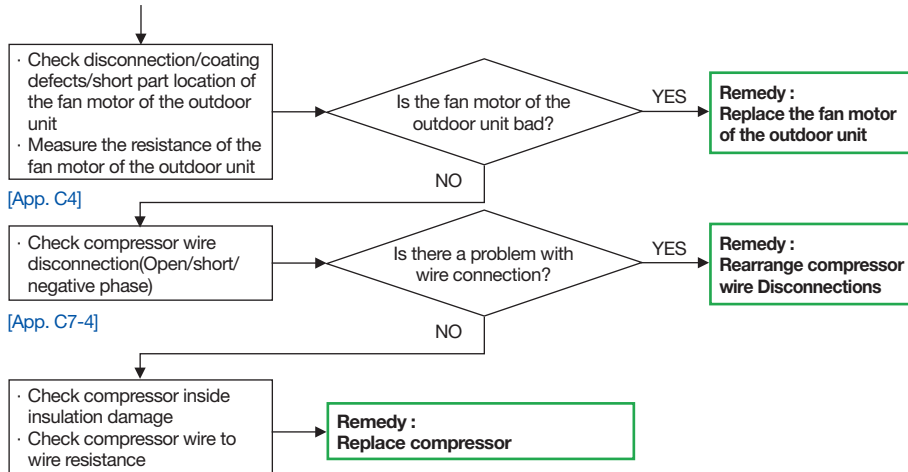

[App. C4]

[App. C7-4]

[App. C3]

※ **Parts Replacement Procedure(Recommended)**



Field failure examples

- Disuse of the ground cord



- Mis-wiring of the compressor wire



Bad operation of AC Fan

Symptoms	Cause of symptoms	Check Point
Bad operation of the AC FAN (Indoor AC fan applied model)	<ul style="list-style-type: none"> Fan constraint Bad wiring of the AC motor Bad AC motor capacitor Decline of the applied voltage(over 20%) Bad PCBA 	<ul style="list-style-type: none"> Check the status of Fan constraint Check the wiring status of the motor Check the capacitor Check the applied voltage Check whether the PCBA is bad



Warning

Before checking PCBA or each outdoor/indoor electric parts, wait for 3 minutes after the power is off.
When measuring at standby state of power supply, after checking the measurement mode of the meter, be careful of the short-circuits with other parts.

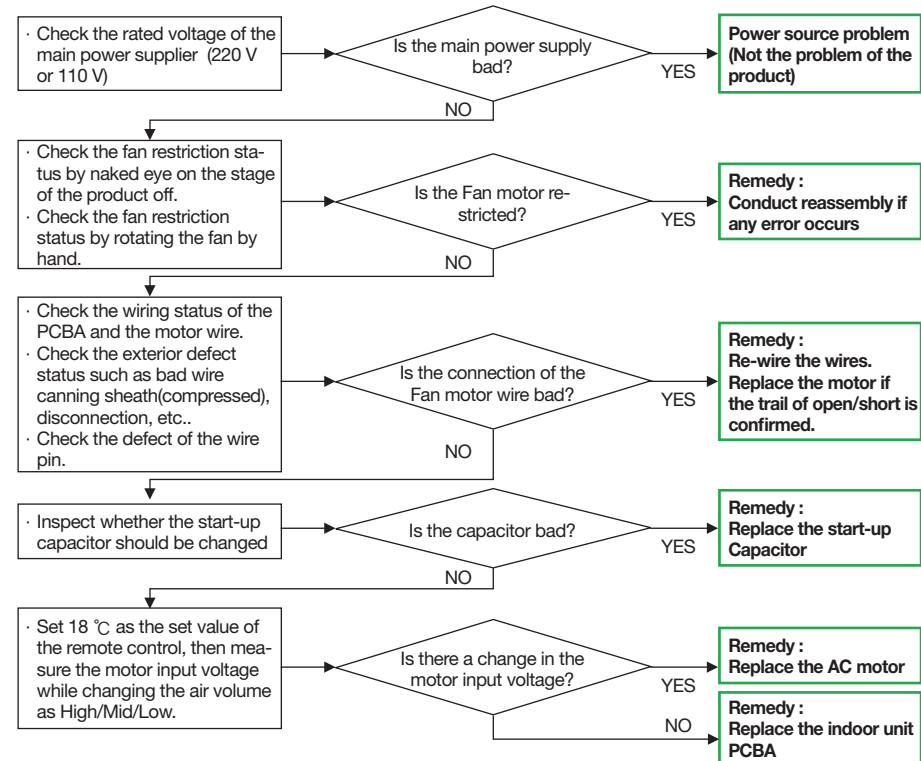

※ **Parts Replacement Procedure(Recommended)**



※ Replace the PCBA if there is no change of the motor input voltage upon change of the air volume of the indoor unit under the condition of operation of the outdoor unit.

3.T/S Guide (Error Code)

 **LG Electronics**

3. T/S Guide (Error Code)

- CH 01 Indoor Unit Room Temp Sensor Open/Short
- CH 02 Indoor Unit Inlet Pipe Sensor Open/Short
- CH 06 Indoor Unit Outlet Pipe Sensor Open/Short
- CH 12 Indoor Unit Middle Pipe Sensor Open/Short

Error Code	Error Detection	Cause of Error	Check Point
CH01	Open/Short of the indoor room temperature sensor	<ul style="list-style-type: none"> · Sensor mis-wiring/short · Penetration of moisture to the sensor 	<ul style="list-style-type: none"> · Check mis-wiring of the sensor connector
CH02	Open/Short of the indoor heat exchanger inlet pipe sensor	<ul style="list-style-type: none"> · Bad canning sheath · Sensor housing removed 	<ul style="list-style-type: none"> · Check the part of the bad sensor wire canning sheath/short · Check whether the sensor single product is bad
CH06	Open/Short of the indoor heat exchanger outlet pipe sensor		
CH12	Open/Short of the indoor heat exchanger mid-pipe sensor		



Warning Before checking PCBA or each outdoor/indoor electric parts, wait for 3 minutes after the power is off.
When measuring at standby state of power supply, after checking the measurement mode of the meter, be careful of the short-circuits with other parts.

※ Check the connector side of the indoor unit PCBA when Error Code occurs. If Short key or Float Switch(Drain Pump) is connected to the corresponding sensor connector, follow the Flow Chart of the Error Code 04.

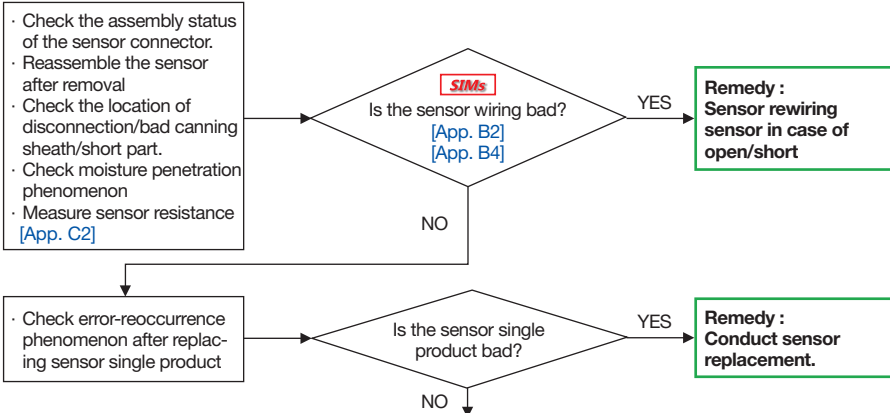

※ Be sure to confirm the status of the installation environment and the sensor as the corresponding error is less likely to have PCBA problem.

※ Parts Replacement Procedure(Recommended)

Temperature Sensor

★ In case of the Error code occurrence caused by sensor error, the bad phenomenon can be figured out with reference to the temperature value read from the sensor by utilizing MV before decomposition.

※ Pipe In/Out sensor may not exist depending on the product, so proceed the service referring to SVC Manual.

■ CH 03 Bad communication of wired remote control

Error Code	Error Detection	Cause of Error	Check Point
CH03	Bad communication of the wired remote control	<ul style="list-style-type: none"> · Interference (Twisted/Non Separation)of AC Line and wired remote control line · Poor contact/Disconnection of wired remote control(DC Line) and PCBA harness · PCBA harness Flooding/corrosion · Remote control fault · Indoor unit PCBA fault 	<ul style="list-style-type: none"> · Check the molding status of the wired remote control wire. · Check the interference status with DC line(Twisted/Mixed/Non-separation) · Check communication cable problem · Check harness Flooding/corrosion · Check Remote control fault · Check Indoor unit PCBA fault



Warning Before checking PCBA or each outdoor/indoor electric parts, wait for 3 minutes after the power is off.
When measuring at standby state of power supply, after checking the measurement mode of the meter, be careful of the short-circuits with other parts.

★ CH03 Error arising from the product which does not use wired remote control may be caused by short or corrosion due to the insufficient clean-up of the PCBA wired remote control connector line.
- In case of the wired remote control disuse model, it can be occurred when product reset after commissioning(after using wired remote control when installing) is not performed.

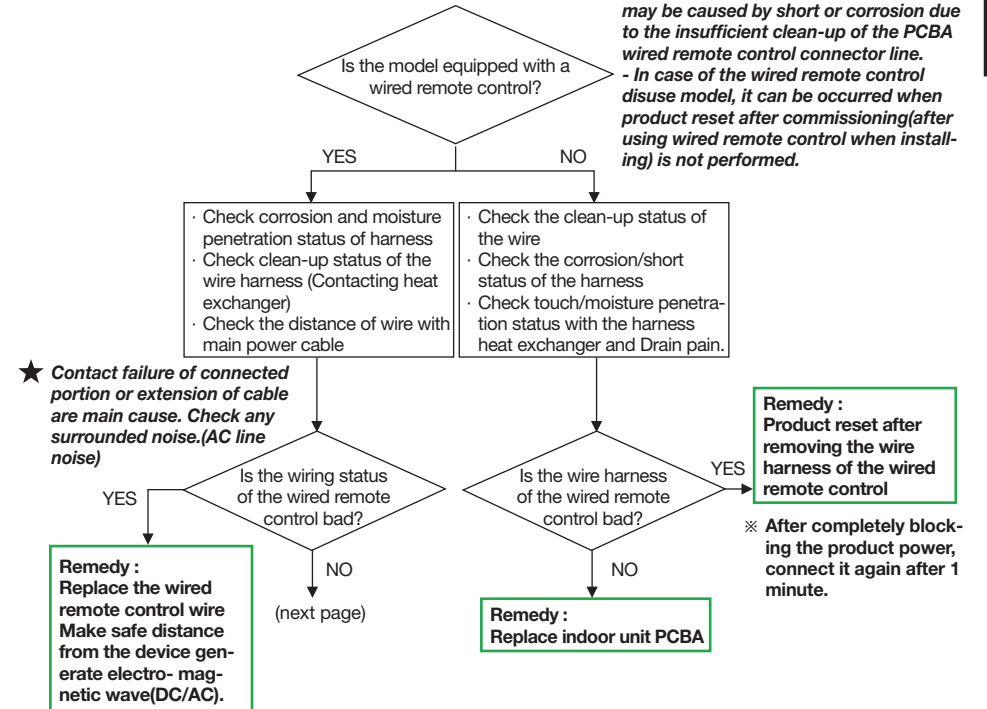

★ Contact failure of connected portion or extension of cable are main cause. Check any surrounded noise.(AC line noise)

※ After completely blocking the product power, connect it again after 1 minute.

3. T/S Guide (Error Code)

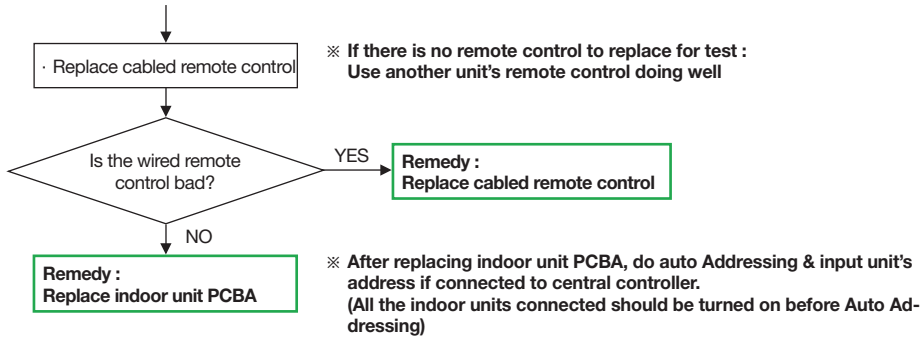

※ Parts Replacement Procedure(Recommended)



Field failure examples

- Molding with external power supplier(Non-separation)



- Wire of the wired remote control touched the heat exchanger

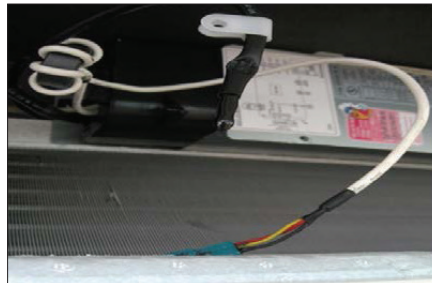

- Short by the moisture penetration to the wire of the wired remote control

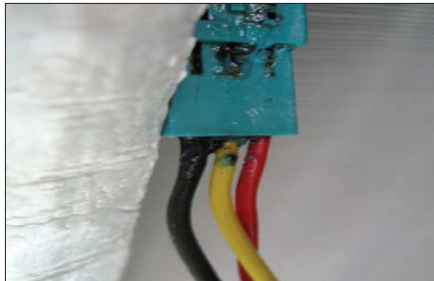

CH 04 Float Switch Error (Optional)

Error Code	Error Detection	Cause of Error	Check Point
CH04	Float switch error	<ul style="list-style-type: none"> · Drain pump fault · Drain hose clogging · Float switch fault 	<ul style="list-style-type: none"> · Check drain pump / float switch · Check drain pipe location · Check clogging of drain pipe · Check short key in the indoor unit PCBA



Warning

Before checking PCBA or each outdoor/indoor electric parts, wait for 3 minutes after the power is off.
When measuring at standby state of power supply, after checking the measurement mode of the meter, be careful of the short-circuits with other parts.

※ Proceed with SVC after distinguishing the model which uses/does not use Float switch.

★ Float switch unused model can arise Error due to the removal or non-installation of the short key in the indoor unit PCBA.

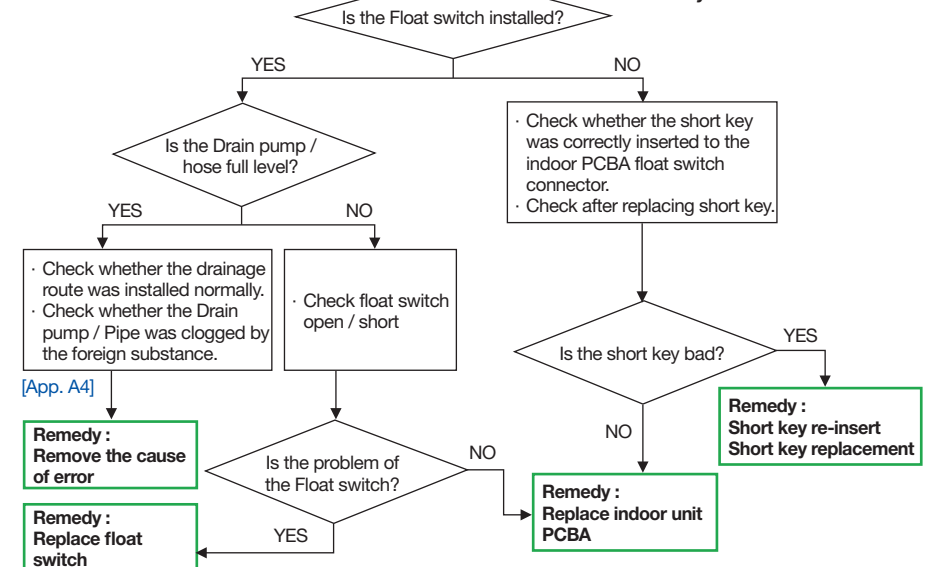

★ In case of the model using Float switch, if CH04 occurs even when inserting short key to the PCBA Connector side, judge it as PCBA fault and replace it. Otherwise, do not replace the PCBA.

※ Be sure to confirm the status of the installation environment and the sensor as the corresponding error is less likely to have PCBA problem.

※ Parts Replacement Procedure(Recommended)



Field failure examples



3. T/S Guide (Error Code)

■ CH 05/53/93 Indoor/Outdoor Unit communication Error

Error Code	Error Detection	Cause of Error	Check Point
CH05 CH53 CH93	Indoor / outdoor unit communication error	<ul style="list-style-type: none"> No power on indoor unit Indoor/outdoor unit power connection error / communication line not installed Communication error caused by external noise Indoor/outdoor unit communication circuit parts burned 	<ul style="list-style-type: none"> Disconnection of the transmission connection Improper connection of terminal block communication wire Improper wiring of communication L-N wire(indoor / outdoor unit communication wire) No power supply due to indoor/outdoor unit PCBA burn



Warning Before checking PCBA or each outdoor/indoor electric parts, wait for 3 minutes after the power is off. When measuring at standby state of power supply, after checking the measurement mode of the meter, be careful of the short-circuits with other parts.

- Check the connection status of the ground wire.
- Check the connection status of the power wire and communication wire (L & N)
- Measure the resistance of the communication line
- Check corrosion status and contact point of the indoor/outdoor connector

[App. A3]
[App. C7-4]

- ★ - If CH10 occurs when starting up the product after removing indoor BLDC connector, judge it as communication error due to the bad indoor motor.
- If CH67 occurs when starting up the product after removing outdoor BLDC connector, judge it as communication error due to the bad outdoor motor.

SIMs [App. B2]

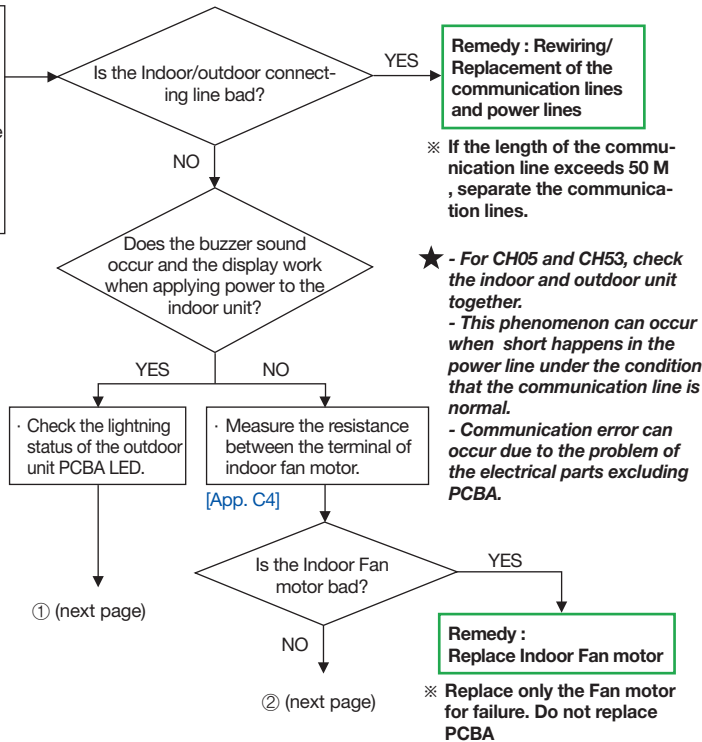

※ In case it is not type 1 or 2, check within 3 minutes as LED becomes off after 3 minutes under the state of product non-startup after applying power.

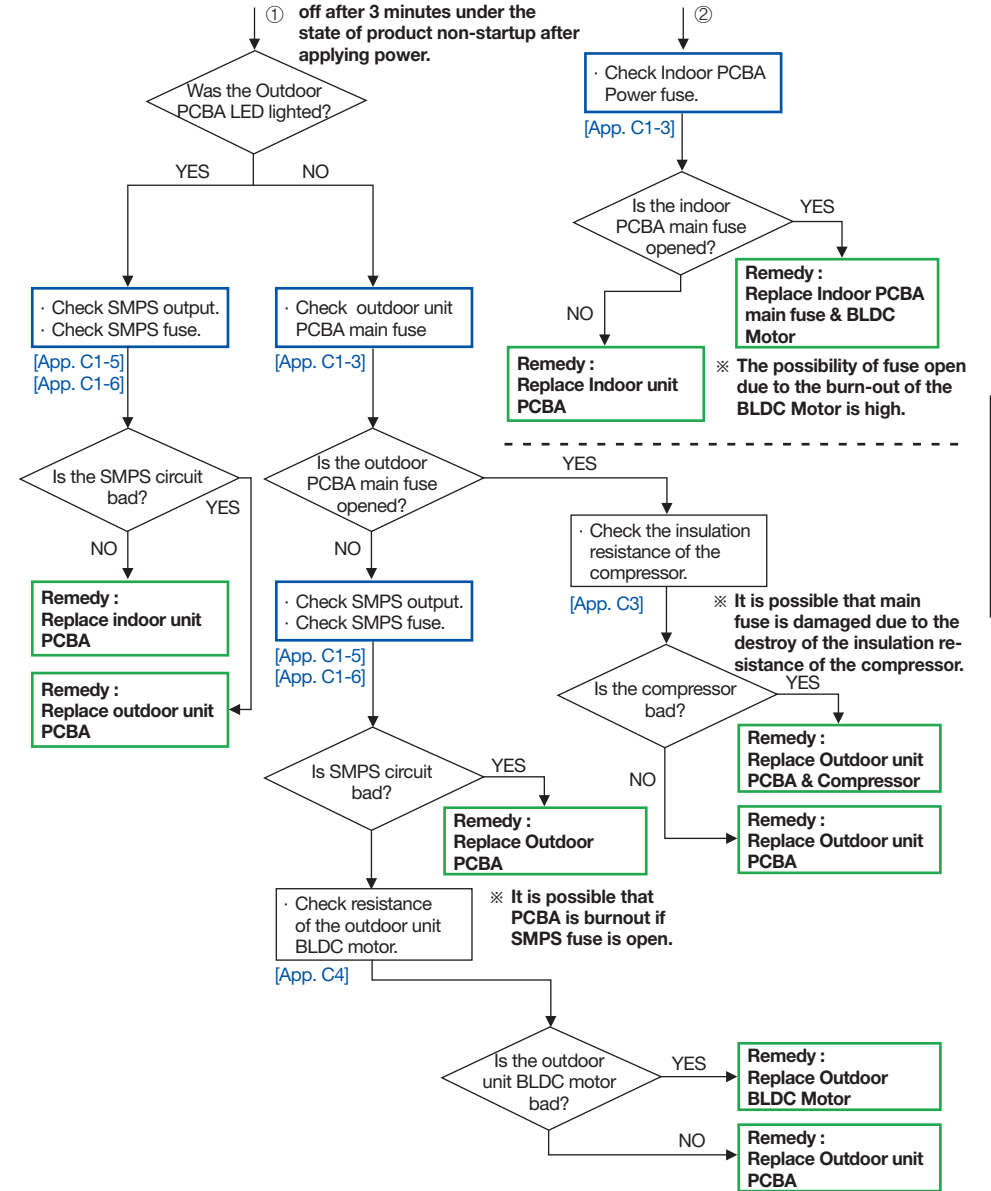

3. T/S Guide (Error Code)

※ Parts Replacement Procedure(Recommended)



Field failure examples

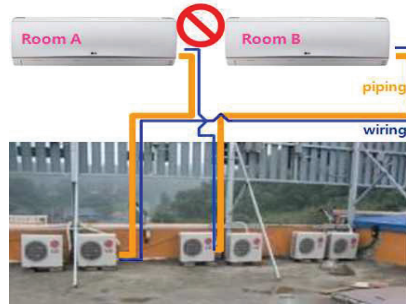
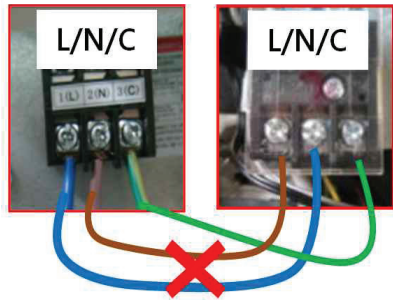

■ CH 09 Indoor Unit EEPROM Error

Error Code	Error Detection	Cause of Error	Check Point
CH09	Indoor EEPROM error (Option PCBA)	· Poor connection of option PCBA	Check the connection status of the option PCBA(verify with hands)

⚠ Warning

Before checking PCBA or each outdoor/indoor electric parts, wait for 3 minutes after the power is off.
When measuring at standby state of power supply, after checking the measurement mode of the meter, be careful of the short-circuits with other parts.

Check if the Option PCBA is properly connected.

※ Parts Replacement Procedure(Recommended)

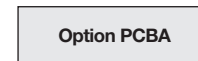

3. T/S Guide (Error Code)

■ CH 10 Indoor BLDC Fan Locking

Error Code	Error Detection	Cause of Error	Check Point
CH10	Indoor BLDC fan locking (faulty motor operation)	<ul style="list-style-type: none"> Fan lock by physical force (foreign structure stuck in the motor) Poor connection of motor connector Motor failure PCBA failure 	<ul style="list-style-type: none"> Structural locking of fan Poor connection of the motor connector Check Motor failure Check PCBA failure



Warning Before checking PCBA or each outdoor/indoor electric parts, wait for 3 minutes after the power is off. When measuring at standby state of power supply, after checking the measurement mode of the meter, be careful of the short-circuits with other parts.

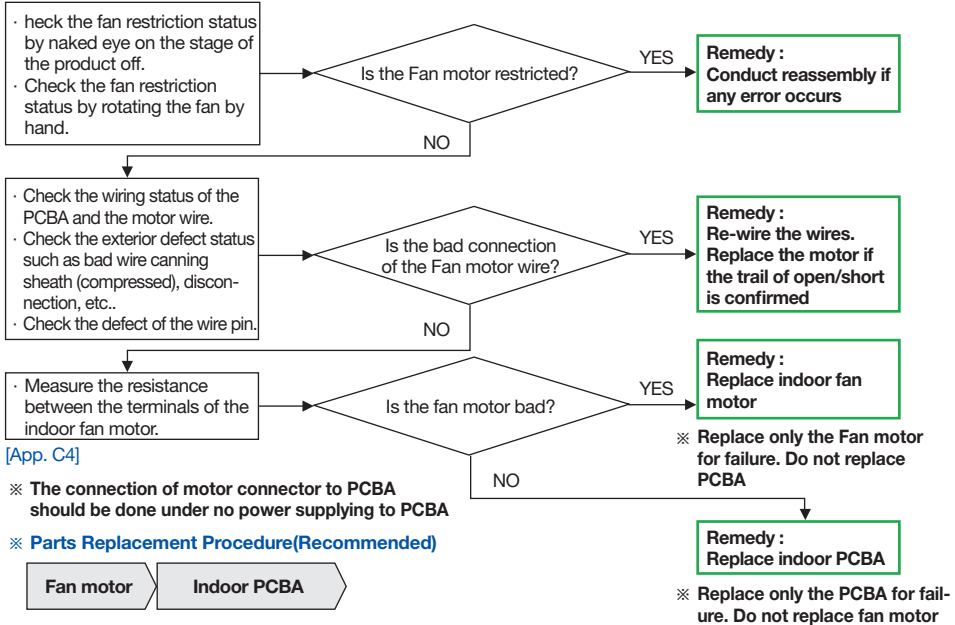

Field failure examples

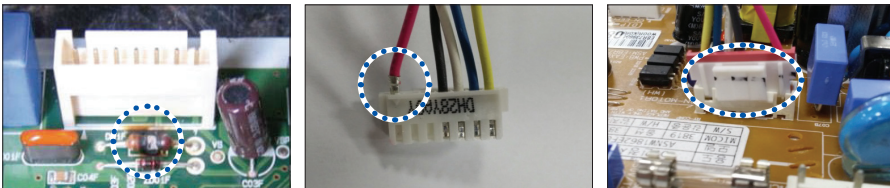

■ CH 21 High Current Into the Compressor (DC Peak) CH 29 Compressor input Phase Current is High

Error Code	Error Detection	Cause of Error	Check Point
CH21	High current into the compressor(DC Peak)	<ul style="list-style-type: none"> Over load operation (Indoor/outdoor fan constraint, screened, blocked, cycle issue) Refrigerant leak Disconnection/short-circuit inside compressor Compressor failure Burned parts inside PCBA(IPM failure) 	<ul style="list-style-type: none"> Check Indoor/outdoor fan constraint, screened/flow structure Check refrigerant leakage Check compressor wire open/short Check compressor insulation damage Check if IPM burned
CH29	Compressor input phase current is high	<ul style="list-style-type: none"> Over load operation (Indoor/outdoor fan constraint, screened, blocked, cycle issue) Refrigerant leak Disconnection/short-circuit inside compressor Compressor failure Burned parts inside PCBA(IPM failure) 	<ul style="list-style-type: none"> Check Indoor/outdoor fan constraint, screened/flow structure Check refrigerant leakage Check compressor wire open/short Check compressor insulation damage Check if IPM burned



Warning Before checking PCBA or each outdoor/indoor electric parts, wait for 3 minutes after the power is off. When measuring at standby state of power supply, after checking the measurement mode of the meter, be careful of the short-circuits with other parts.

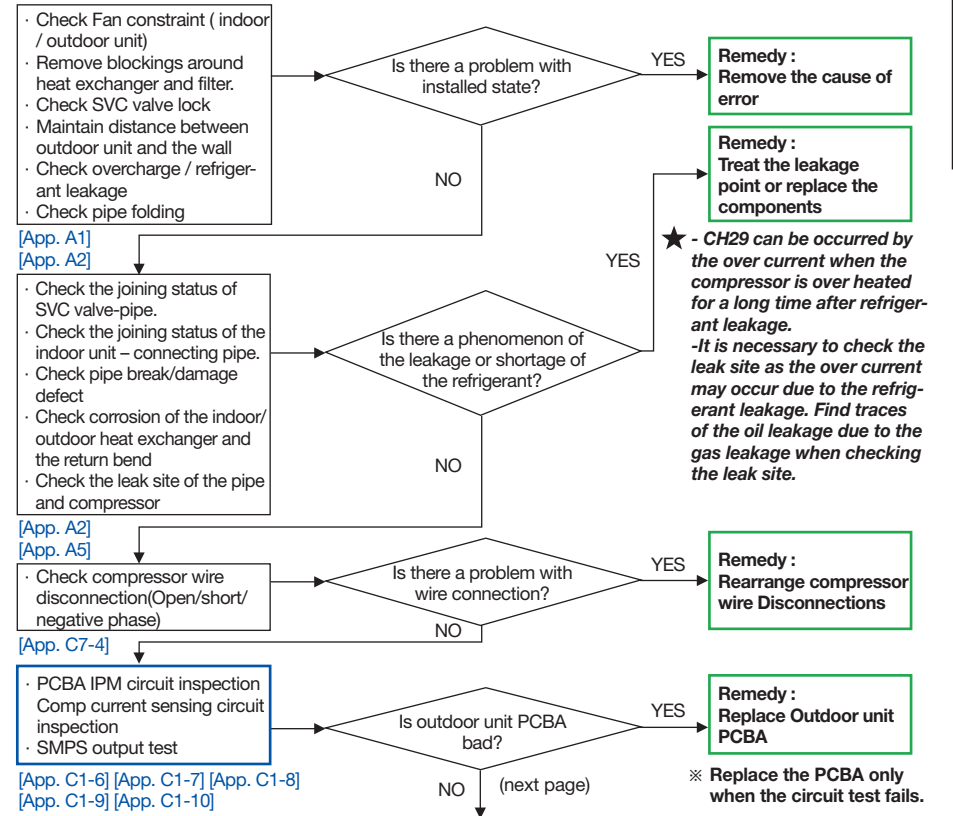

3. T/S Guide (Error Code)

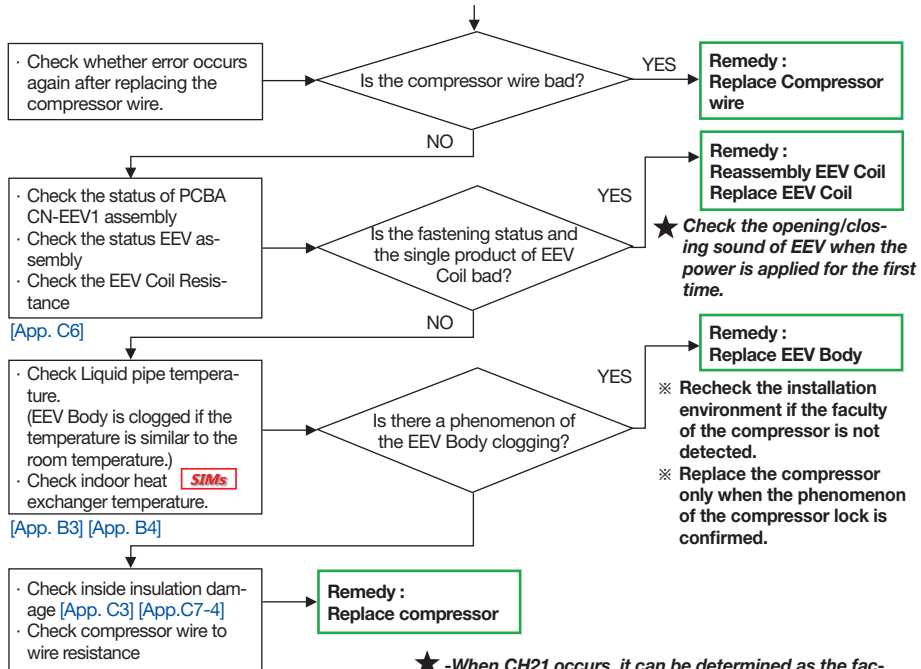

Field failure examples

- Compressor crack



- Mis-connected the compressor wire



★ -When CH21 occurs, it can be determined as the faculty of the PCBA if CH21 occurs in the same way when starting up the product after removing the compressor wire connector.

-When CH21 occurs, it can be determined as the faculty of the compressor if CH26 occurs in the same way when starting up the product after removing the compressor wire connector.

SIMs [App. B2]

※ **Parts Replacement Procedure(Recommended)**

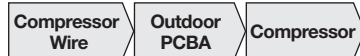

- Compressor wire short

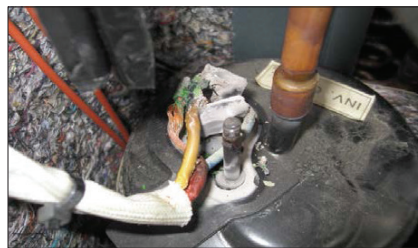

■ CH 22 AC input Current is Higher then the Limit

Error Code	Error Detection	Cause of Error	Check Point
CH22	Ac input current is higher than the limit.	<ul style="list-style-type: none"> Over load operation (outdoor fan constraint, screened, blocked) Input voltage error (low voltage) Burned parts inside PCBA 	<ul style="list-style-type: none"> Check input voltage Check outdoor fan constraint / screened/ flow structure Check PCBA current sensor parts



Warning

Before checking PCBA or each outdoor/indoor electric parts, wait for 3 minutes after the power is off.
When measuring at standby state of power supply, after checking the measurement mode of the meter, be careful of the short-circuits with other parts.

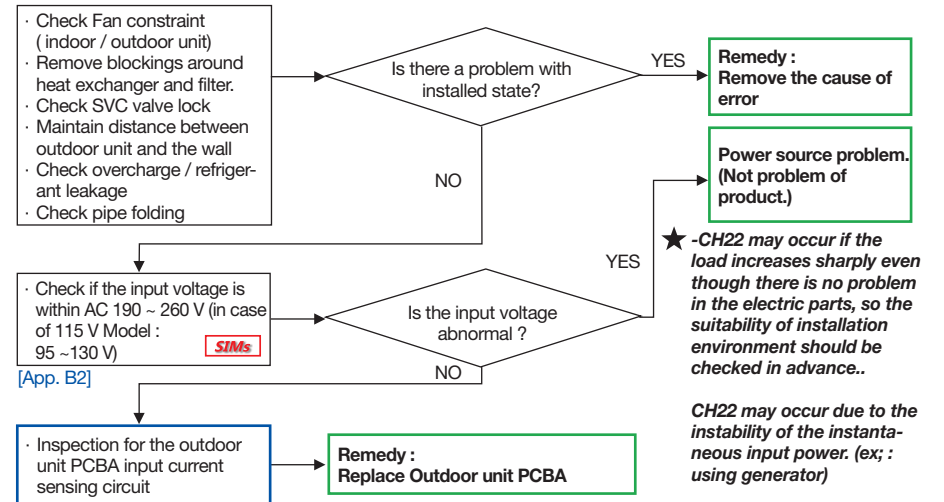

★ -CH22 may occur if the load increases sharply even though there is no problem in the electric parts, so the suitability of installation environment should be checked in advance..

CH22 may occur due to the instability of the instantaneous input power. (ex; : using generator)

※ The corresponding Error occurs due to the bad environment of the installation and it is less likely that the PCBA is bad. (if the installation environment is bad, the phenomenon may not be solved even when replacing PCBA.)

3. T/S Guide (Error Code)

Field failure examples

- Airflow to condenser is blocked (1)



- Airflow to condenser is blocked (2)



- Service valve closed



■ CH 23 DC Link Voltage Low / High

Error Code	Error Detection	Cause of Error	Check Point
CH23	DC Link Voltage Low/High	<ul style="list-style-type: none"> Input voltage error(low voltage) Reactor disconnection / Bad fastening PCBA failure 	<ul style="list-style-type: none"> Check input voltage Reactor wire abnormal/open Check PCBA DC Link voltage sensor part



Warning

Before checking PCBA or each outdoor/indoor electric parts, wait for 3 minutes after the power is off.
When measuring at standby state of power supply, after checking the measurement mode of the meter, be careful of the short-circuits with other parts.

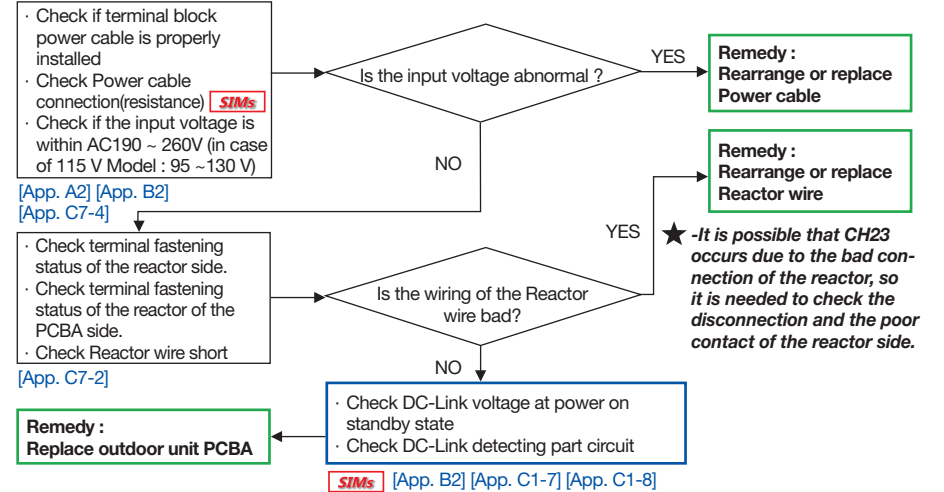

※ Parts Replacement Procedure(Recommended)

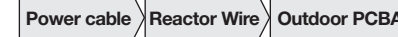

Field failure examples

- Reactor wire short

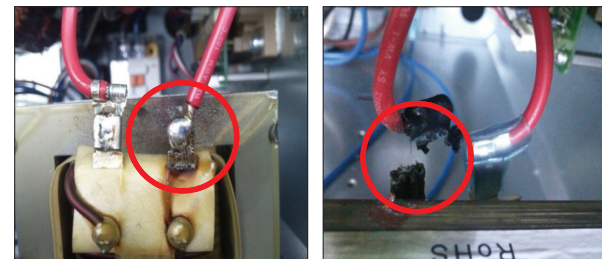

3. T/S Guide (Error Code)

■ CH 26 DC Compressor Position Error

Error Code	Error Detection	Cause of Error	Check Point
CH26	DC Comp Position Error	<ul style="list-style-type: none"> Poor connection of compressor connector Compressor failure PCBA failure 	<ul style="list-style-type: none"> Check compressor wire open/short Check compressor insulation damage



Before checking PCBA or each outdoor/indoor electric parts, wait for 3 minutes after the power is off.
When measuring at standby state of power supply, after checking the measurement mode of the meter, be careful of the short-circuits with other parts.

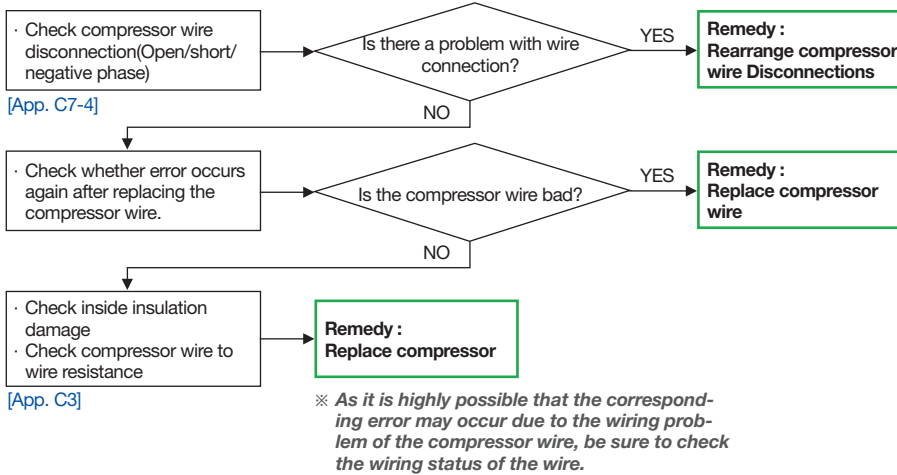

※ Parts Replacement Procedure(Recommended)



■ CH 27 PSC Fault Error

Error Code	Error Detection	Cause of Error	Check Point
CH27	PSC Fault error Over-current on AC → DC converter circuit	<ul style="list-style-type: none"> Overload outdoor fan constraint, screened, blocked) Bad Reactor fastening Burned PCBA internal parts (PSC module) 	<ul style="list-style-type: none"> Check outdoor fan constraint / screened / flow structure Check whether the reactor fastening is bad Check for PCBA internal part burn



Before checking PCBA or each outdoor/indoor electric parts, wait for 3 minutes after the power is off.
When measuring at standby state of power supply, after checking the measurement mode of the meter, be careful of the short-circuits with other parts.

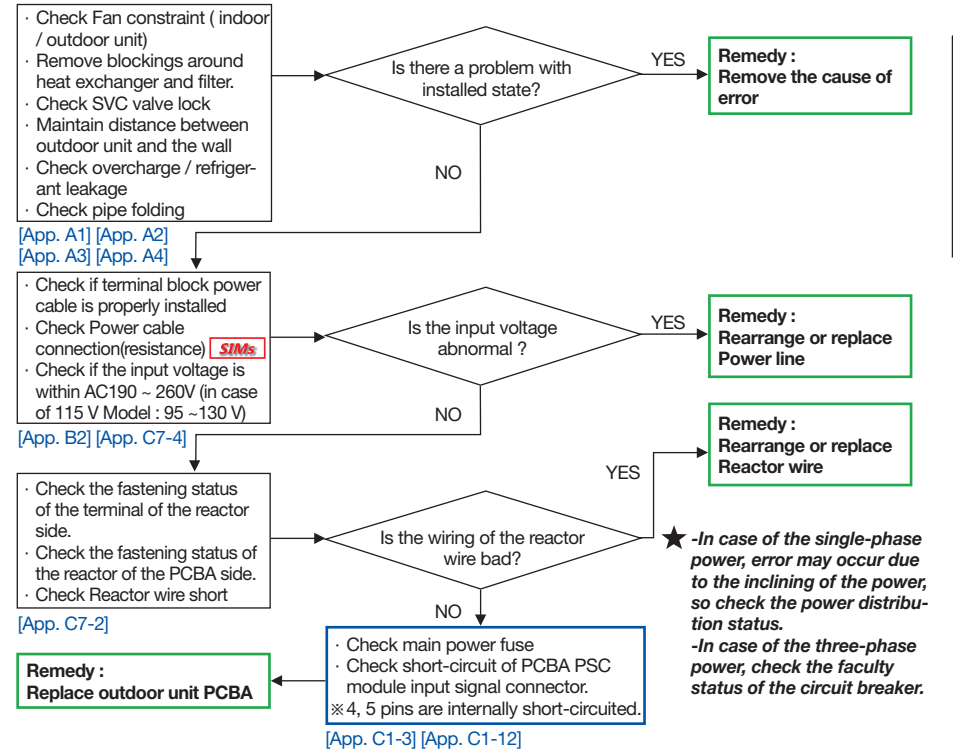

※ Parts Replacement Procedure(Recommended)



3. T/S Guide (Error Code)

■ CH 32 High Temperature in Discharge Pipe of the Inverter Compressor

Error Code	Error Detection	Cause of Error	Check Point
CH32	High temperature in Discharge pipe of the inverter compressor	<ul style="list-style-type: none"> Overload operation (outdoor fan constraint, screened, blocked) Poor INV Comp Discharge sensor Refrigerant leakage (insufficient) EEV connector displaced / poor EEV assembly 	<ul style="list-style-type: none"> Check outdoor fan constraint / screened / flow structure Check refrigerant leakage Check if the sensor is normal Check the status of EEV assembly



Warning

Before checking PCBA or each outdoor/indoor electric parts, wait for 3 minutes after the power is off.
When measuring at standby state of power supply, after checking the measurement mode of the meter, be careful of the short-circuits with other parts.

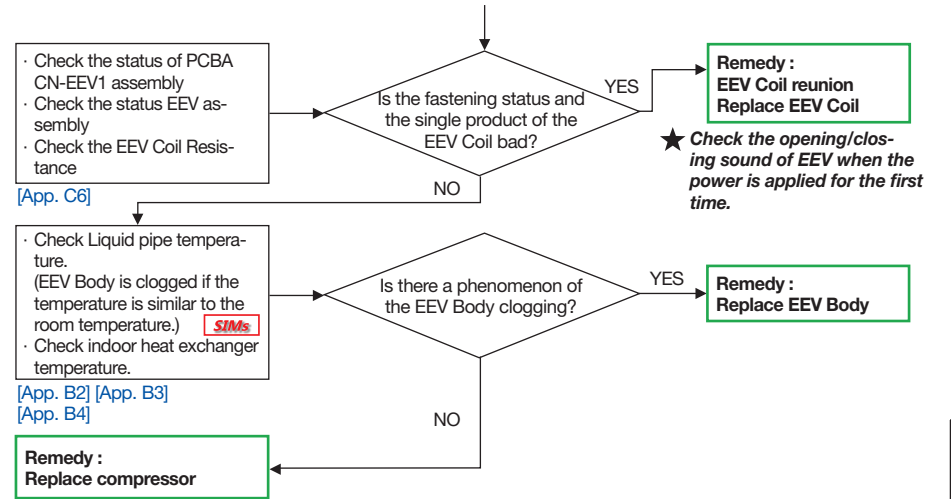
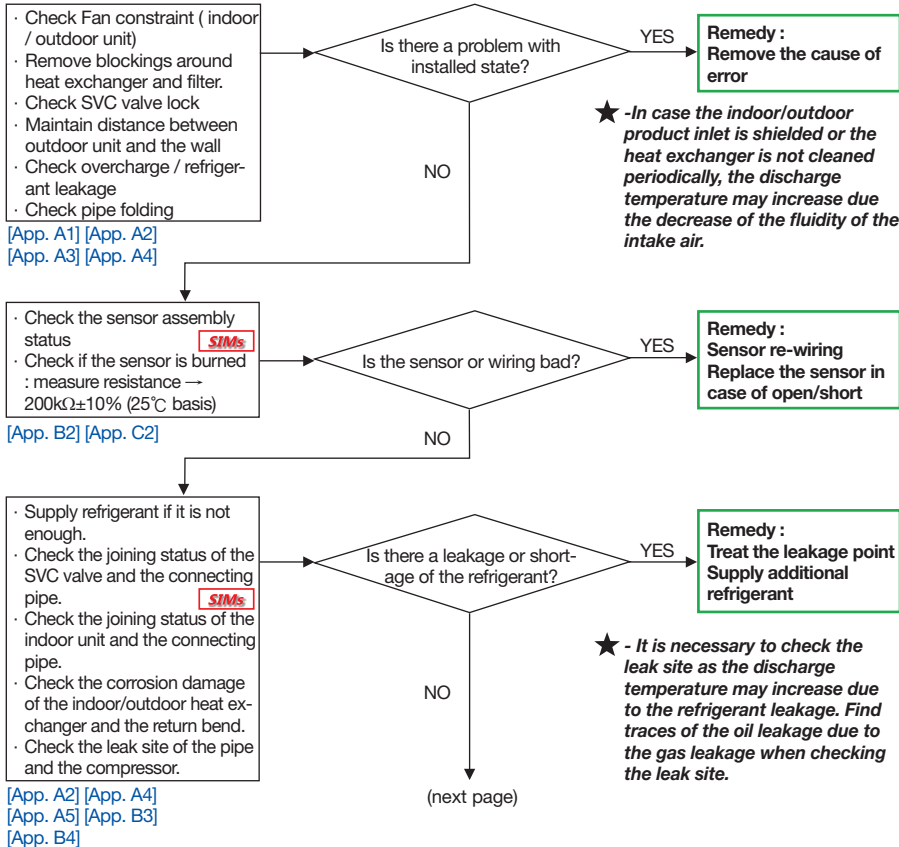

※ Parts Replacement Procedure(Recommended)



Field failure examples

- Airflow to condenser is blocked



3. T/S Guide (Error Code)

■ CH 34 High Pressure Sensor Error (High) CH 35 Low Pressure Sensor Error (Low)

Error Code	Error Detection	Cause of Error	Check Point
CH34	High pressure sensor error (high)	<ul style="list-style-type: none"> Overload operation (outdoor fan constraint, screened, blocked) Refrigerant leakage (insufficient) 	<ul style="list-style-type: none"> Check outdoor fan constraint / screened / flow structure Check refrigerant leakage
CH35	Low pressure sensor error (low)	<ul style="list-style-type: none"> Bad connection of the pressure sensor Bad compressor sensor Bad PCBA 	<ul style="list-style-type: none"> Check the connection status of the compressor sensor Check resistance of the pressure sensor



Warning Before checking PCBA or each outdoor/indoor electric parts, wait for 3 minutes after the power is off.
When measuring at standby state of power supply, after checking the measurement mode of the meter, be careful of the short-circuits with other parts.

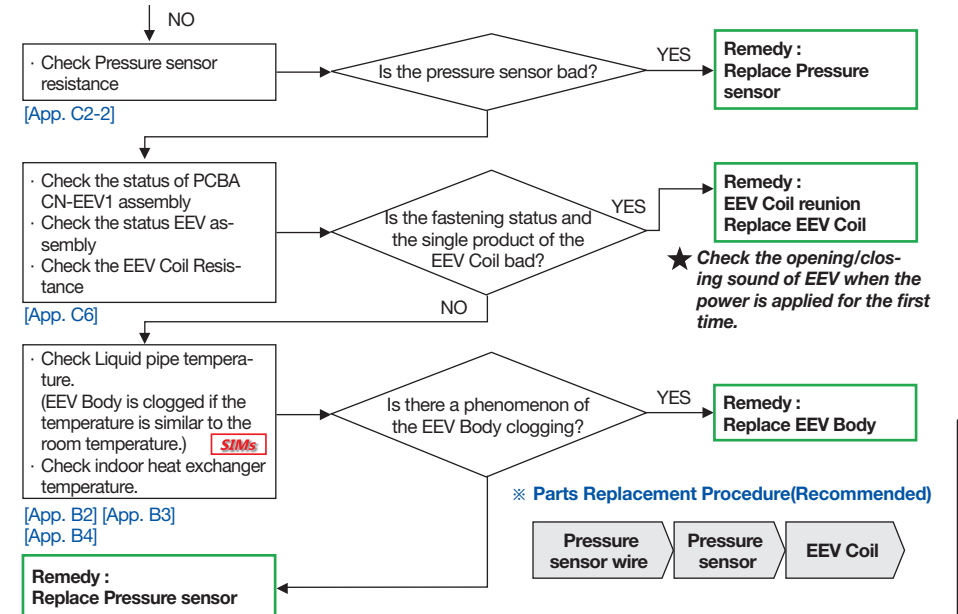
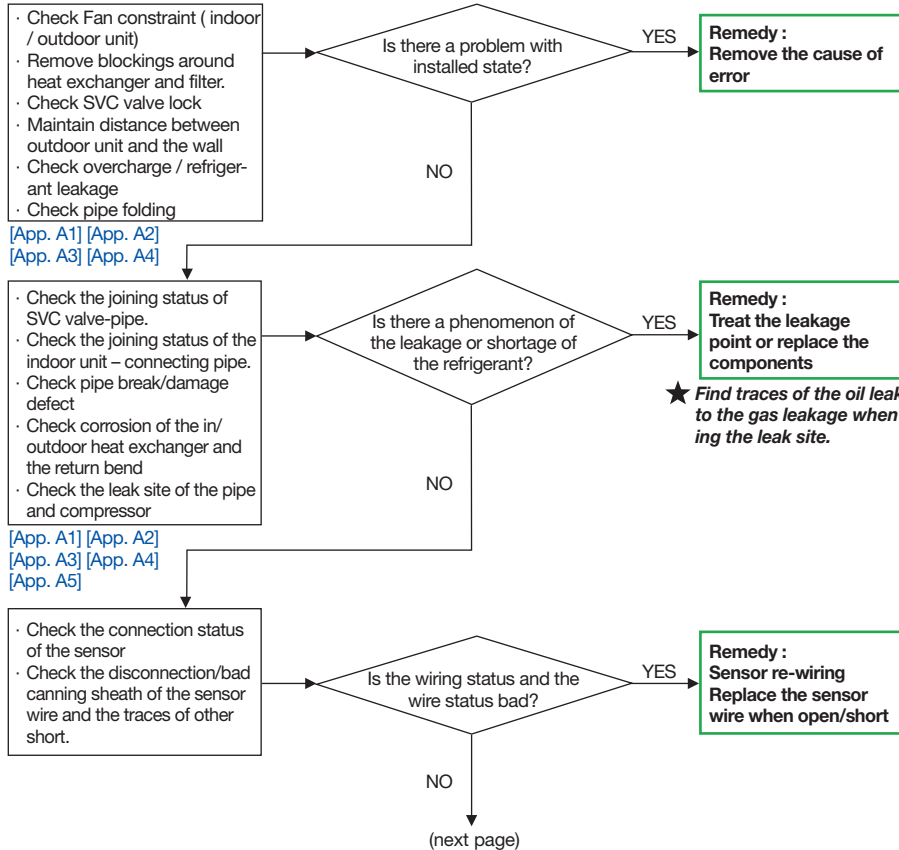

※ Be sure to confirm the status of the installation environment and the sensor as the corresponding error is less likely to have PCBA problem.

3. T/S Guide (Error Code)

■ CH 36/38 Refrigerant Leakage Detection

Error Code	Error Detection	Cause of Error	Check Point
CH36 CH38	Refrigerant leakage detection	<ul style="list-style-type: none"> · Pipe break damage · Bad connection of the pipe · Pipe damage due to the corrosion · corrosion damage of the heat exchanger · Compressor damage(crack) · EEV body clogging · Refrigerant shortage 	<ul style="list-style-type: none"> · Check the connection status of the pipe. · Check the pipe break/damage faulty status · Check the status of the indoor/outdoor heat exchangers · Check the compressor leakage · Check EEV body clogging · Check proper refrigerant quantity · Check the quantity of the refrigerant additionally charged



Before checking PCBA or each outdoor/indoor electric parts, wait for 3 minutes after the power is off.
When measuring at standby state of power supply, after checking the measurement mode of the meter, be careful of the short-circuits with other parts.

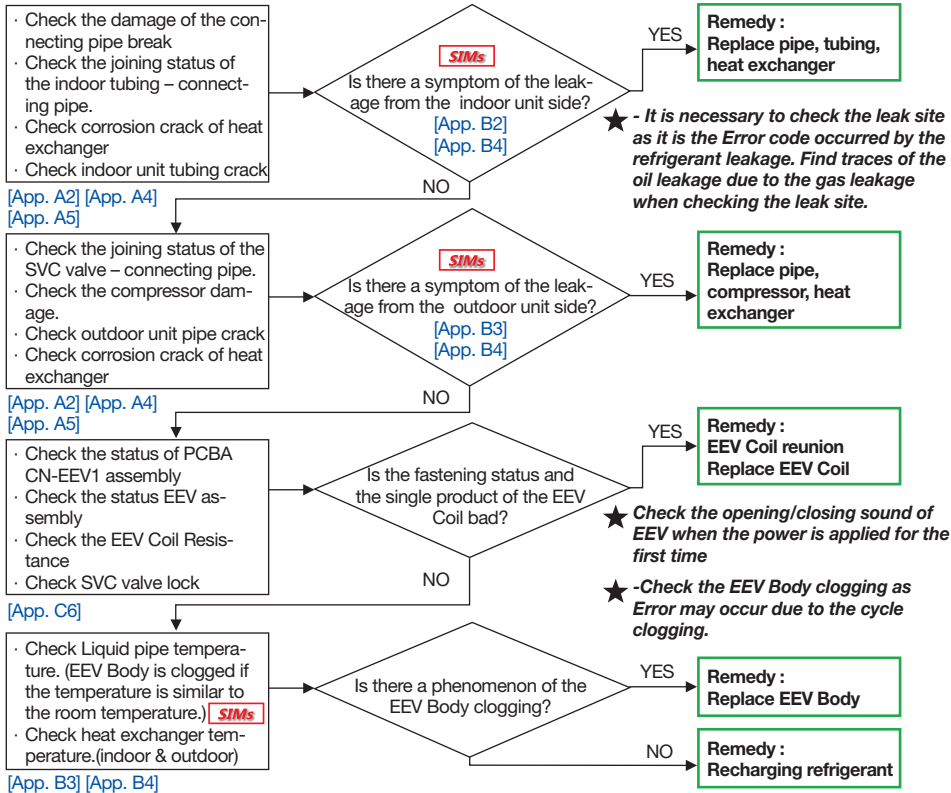

■ CH 37 Failure Compressing Ratio

Error Code	Error Detection	Cause of Error	Check Point
CH37	Failure compressing ratio	<ul style="list-style-type: none"> · Overload operation (outdoor fan constraint, screened, blocked) · SVC valve lock · Bad compressor sensor · EEV connector displaced / poor EEV assembly · EEV Body clogging · Refrigerant leakage (insufficient) · refrigerant overcharge 	<ul style="list-style-type: none"> · Check outdoor fan constraint / screened / flow structure · Check SVC valve lock · Check resistance of pressure sensor · Check the status of EEV assembly · Check EEV clogging · Check refrigerant leakage 3 · Check the quantity of the refrigerant.



Before checking PCBA or each outdoor/indoor electric parts, wait for 3 minutes after the power is off.
When measuring at standby state of power supply, after checking the measurement mode of the meter, be careful of the short-circuits with other parts.

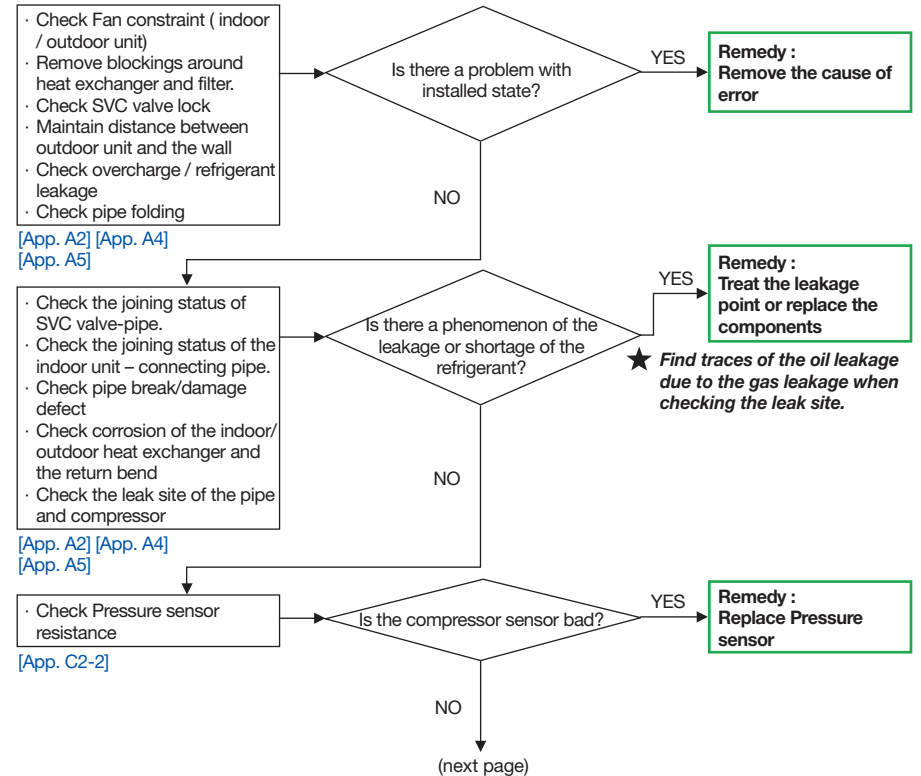

3. T/S Guide (Error Code)

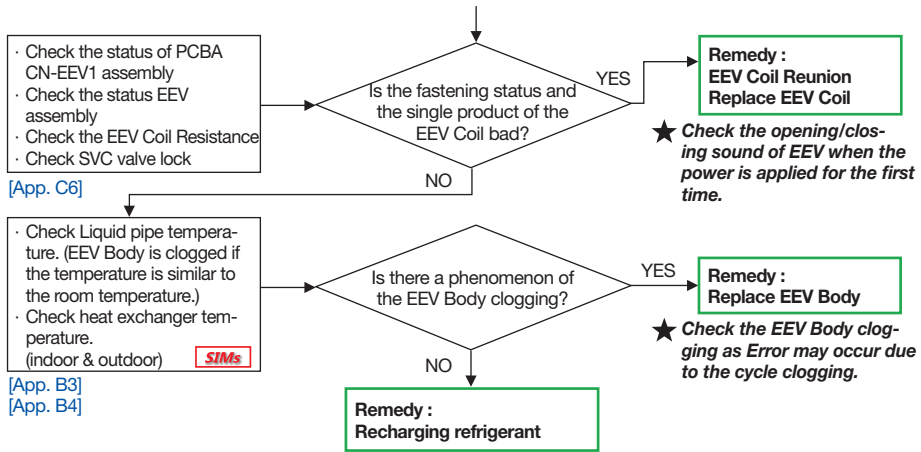

※ Parts Replacement Procedure(Recommended)



■ CH 40 Inverter CT Sensor Open/Short

Error Code	Error Detection	Cause of Error	Check Point
CH40	Inverter CT sensor open/short	· PCBA sensing circuit part burned	-



Warning

Before checking PCBA or each outdoor/indoor electric parts, wait for 3 minutes after the power is off.
When measuring at standby state of power supply, after checking the measurement mode of the meter, be careful of the short-circuits with other parts.

- As CH 40 Error code phenomenon occurs due to the burn-out of the components of the outdoor unit PCBA, replace the PCBA without separate inspection.

※ Parts Replacement Procedure(Recommended)

Outdoor PCBA

3. T/S Guide (Error Code)

- CH 41 Inverter Discharge Sensor Open / Short
- CH 44 Outdoor Air Temperature Open / Short
- CH 45/48 Outdoor Unit Pipe Sensor Open / Short
- CH 46 Compressor Suction Sensor Open / Short

Error Code	Error Detection	Cause of Error	Check Point
CH41	Inverter discharge temperature sensor open or short	· Sensor mis-wiring/Short · Moisture penetration / Bad canning sheath	· Check whether the sensor connector was wired wrongly. · Bad canning sheath of the sensor wire / Short part check · Sensor faulty check
CH44	Outdoor room temperature sensor open or short		
CH45/48	Outdoor sensor (Outdoor heat exchanger)open or short		
CH46	Compressor suction temperature sensor open / short		



Warning Before checking PCBA or each outdoor/indoor electric parts, wait for 3 minutes after the power is off. When measuring at standby state of power supply, after checking the measurement mode of the meter, be careful of the short-circuits with other parts.

- Check the assembly status of the sensor connector.
- Reassemble the sensor after removal
- Check the location of disconnection/bad canning sheath/short part.
- Check moisture penetration phenomenon
- Measure sensor resistance

[App. C2]

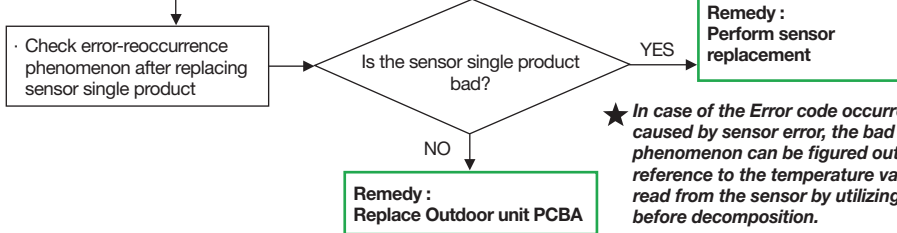

★ In case of the Error code occurrence caused by sensor error, the bad phenomenon can be figured out with reference to the temperature value read from the sensor by utilizing MV before decomposition.

※ Be sure to confirm the status of the installation environment and the sensor as the corresponding error is less likely to have PCBA problem.

※ Pipe In/Out sensor may not exist depending on the product, so proceed the service referring to SVC Manual.

※ Parts Replacement Procedure(Recommended)

Temperature Sensor

- CH 42 Low Pressure Sensor Open / Short
- CH 43 High Pressure Sensor Open / Short

Error Code	Error Detection	Cause of Error	Check Point
CH42	Low pressure Sensor open/short	· Bad wiring of the pressure sensor	· Check whether the sensor connector was wired wrongly.
CH43	High pressure Sensor open/short	· Bad pressure sensor	



Warning Before checking PCBA or each outdoor/indoor electric parts, wait for 3 minutes after the power is off. When measuring at standby state of power supply, after checking the measurement mode of the meter, be careful of the short-circuits with other parts.

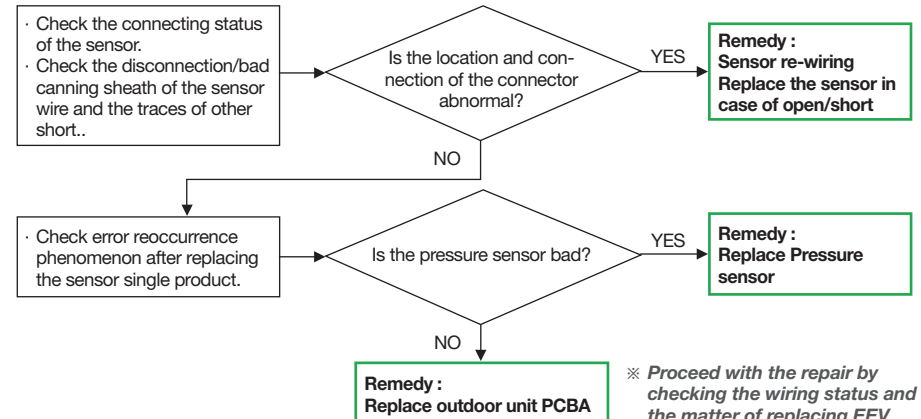

※ Parts Replacement Procedure(Recommended)



※ Proceed with the repair by checking the wiring status and the matter of replacing EEV Coil as the corresponding error is less likely to have PCBA problem.

3. T/S Guide (Error Code)

■ CH 51 Excessive number of access device with over capacity

Error Code	Error Detection	Cause of Error	Check Point
CH51	Excessive number of the over-capacity access unit (Exceeds the sum of the capacity of the indoor unit)	· Mis-wiring of the indoor/outdoor unit	· Check the matching status of the indoor/outdoor unit.

- Case of field defect
- Wrong wiring connection during installation of large numbers of the similar model at the same site.
- In case like this, make sure to double check that wiring connection and piping connection are connected to the same model.

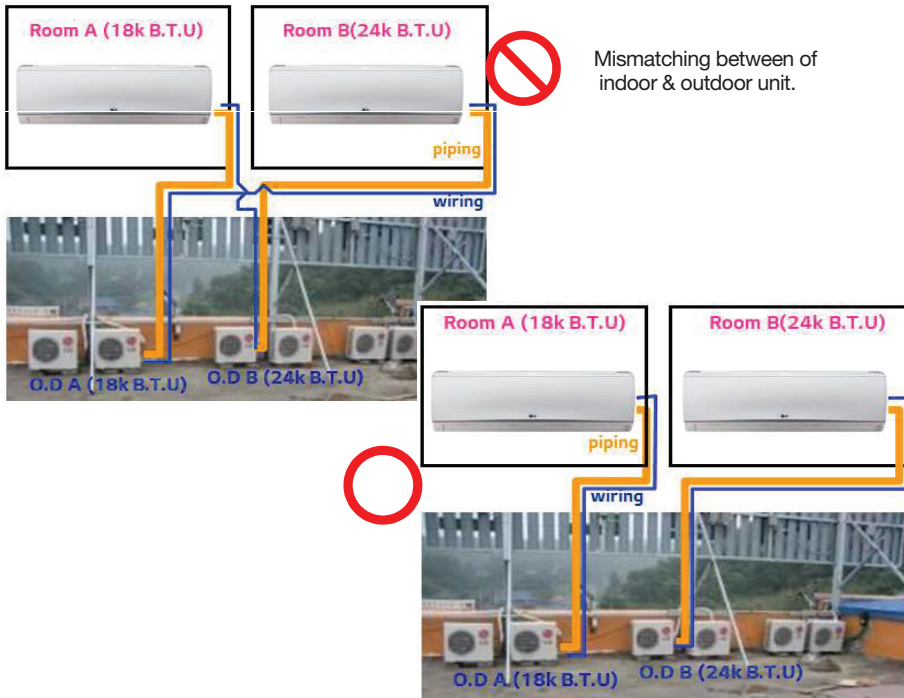

■ CH 61 High Temperature in Condenser Pipe

Error Code	Error Detection	Cause of Error	Check Point
CH61	High temperature in Cond. Pipe	· Overload operation (Fan constraint, screened, blocked) · Heat exchanger contaminated · Poor Cond. pipe sensor assembly / burned · EEV connector displaced/poor EEV assembly	· Check fan constraint, screened, flow structure · Check if refrigerant overcharged · Check the status of sensor assembly / burn · Check the status of EEV assembly



Before checking PCBA or each outdoor/indoor electric parts, wait for 3 minutes after the power is off.
When measuring at standby state of power supply, after checking the measurement mode of the meter, be careful of the short-circuits with other parts.

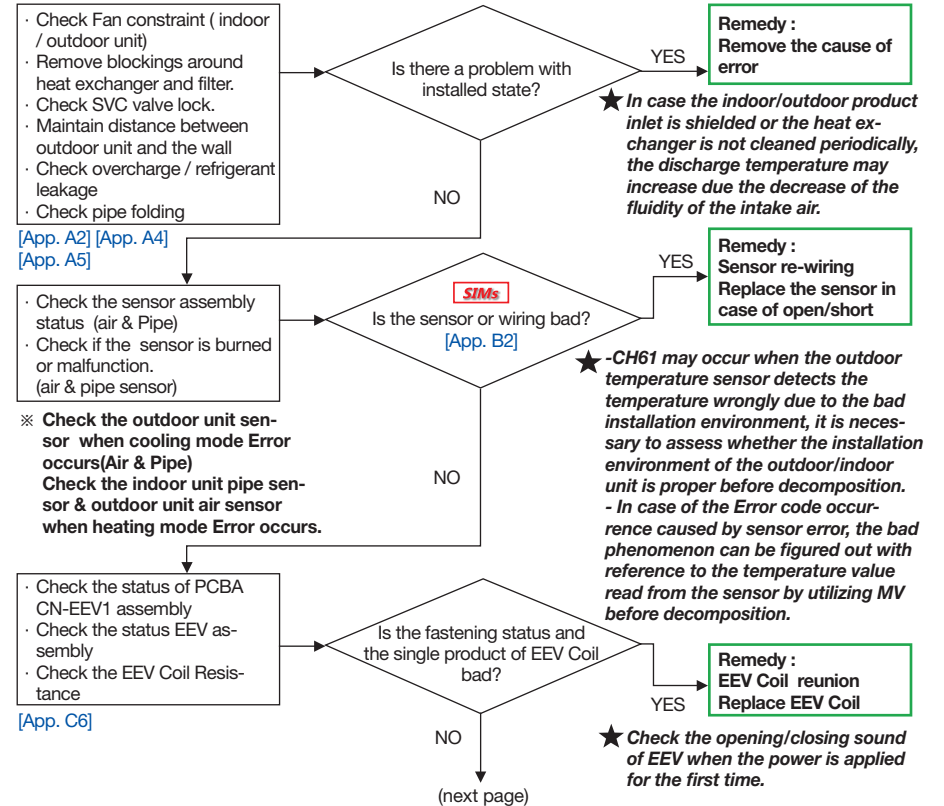

3. T/S Guide (Error Code)

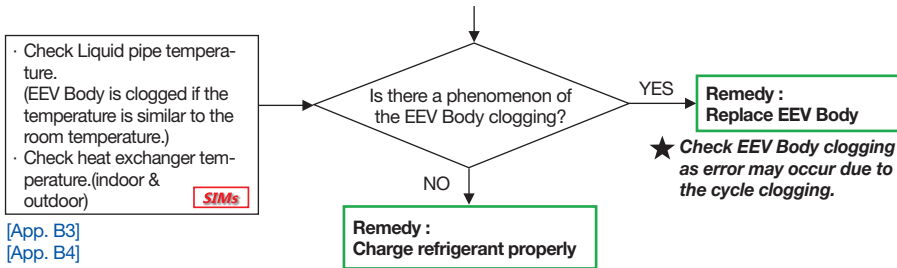

※ **Parts Replacement Procedure(Recommended)**
- When error occurs during cooling mode.



- When error occurs during heating mode.



Field failure examples

- Airflow to condenser is blocked

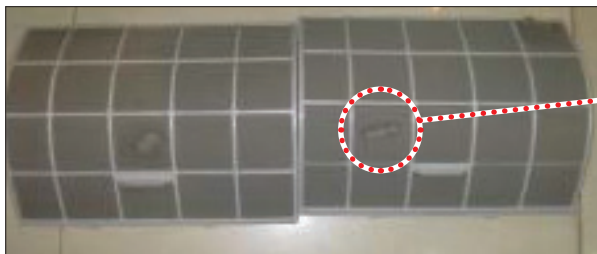

■ CH 62 High Temperature in Outdoor PCBA Heat Sink

Error Code	Error Detection	Cause of Error	Check Point
CH62	High temperature in outdoor PCBA heat sink	<ul style="list-style-type: none"> Improper installation environment Overload operation (outdoor fan constraint, screened, blocked) Poor PCBA heat sink assembly Poor PCBA temperature sensing circuit parts 	<ul style="list-style-type: none"> Check installation environment Check outdoor fan constraint / screened/ flow structure Check for the status of the PCBA heat sink connection Check PCBA temperature sensing parts



Warning
Before checking PCBA or each outdoor/indoor electric parts, wait for 3 minutes after the power is off.
When measuring at standby state of power supply, after checking the measurement mode of the meter, be careful of the short-circuits with other parts.

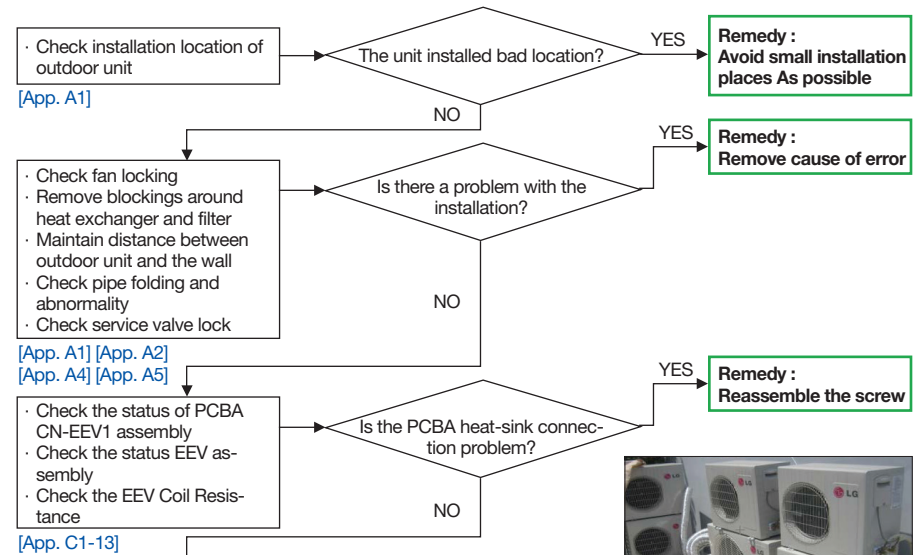

Field failure examples

- Airflow to condenser is blocked

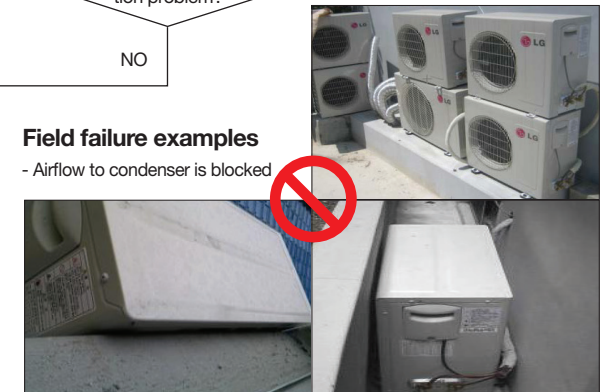

※ The corresponding Error occurs due to the bad environment of the installation and it is less likely that the PCBA is bad. (if the installation environment is bad, the phenomenon may not be solved even when replacing PCBA.)

3. T/S Guide (Error Code)

■ CH 67 Outdoor BLDC Fan Locking

Error Code	Error Detection	Cause of Error	Check Point
CH67	Outdoor BLDC fan locking (faulty motor operation)	<ul style="list-style-type: none"> · Fan lock by physical force (foreign structure stuck in the motor) · Poor connection of motor connector · Motor failure · PCBA failure 	<ul style="list-style-type: none"> · Structural locking of fan · Poor connection of the motor connector · Check motor failure · Check PCBA failure



Before checking PCBA or each outdoor/indoor electric parts, wait for 3 minutes after the power is off.
When measuring at standby state of power supply, after checking the measurement mode of the meter, be careful of the short-circuits with other parts.

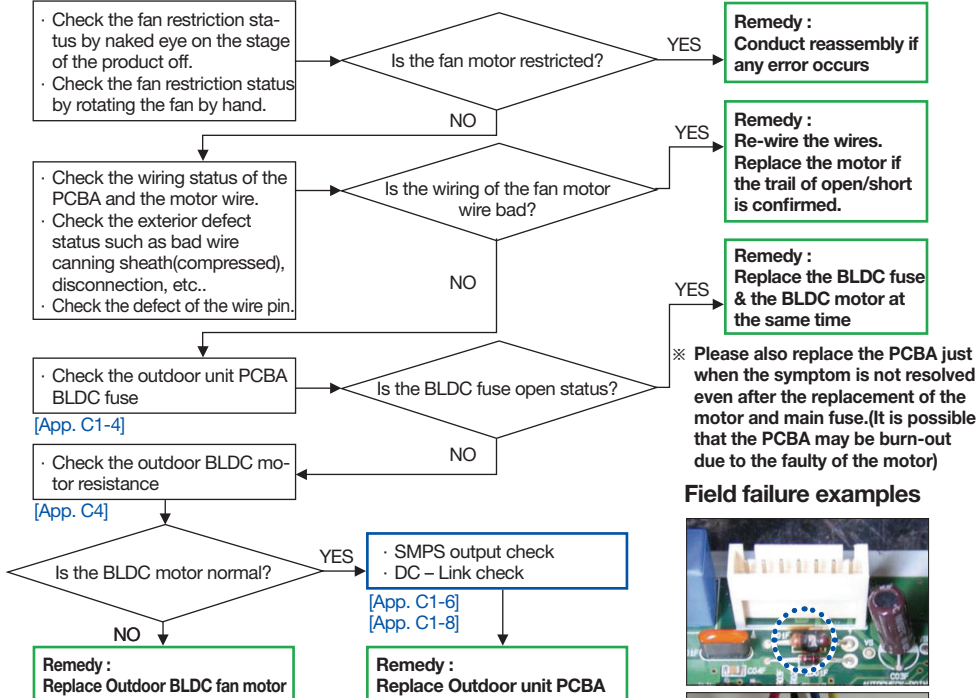

※ Please also replace the PCBA just when the symptom is not resolved even after the replacement of the motor and main fuse.(It is possible that the PCBA may be burn-out due to the faulty of the motor)

Field failure examples

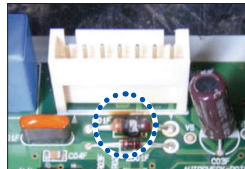

※ The connection of motor connector to PCBA should be done under no power supplying to PCBA

※ Parts Replacement Procedure(Recommended)

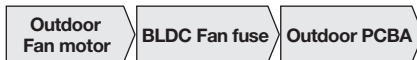

■ CH 72 Switching for 4 Way Valve is Failed

Error Code	Error Detection	Cause of Error	Check Point
CH72	Switching for 4 way valve is failed	<ul style="list-style-type: none"> · Indoor/outdoor sensor short/open · Disconnection of 4 way valve connector · 4 way valve open/short · Burned part inside PCBA 	<ul style="list-style-type: none"> · Check sensor status (indoor/outdoor middle pipe) · Check connector for 4 way valve · Check 4 way valve coil resistance · Check CN-4 way output voltage



Before checking PCBA or each outdoor/indoor electric parts, wait for 3 minutes after the power is off.
When measuring at standby state of power supply, after checking the measurement mode of the meter, be careful of the short-circuits with other parts.

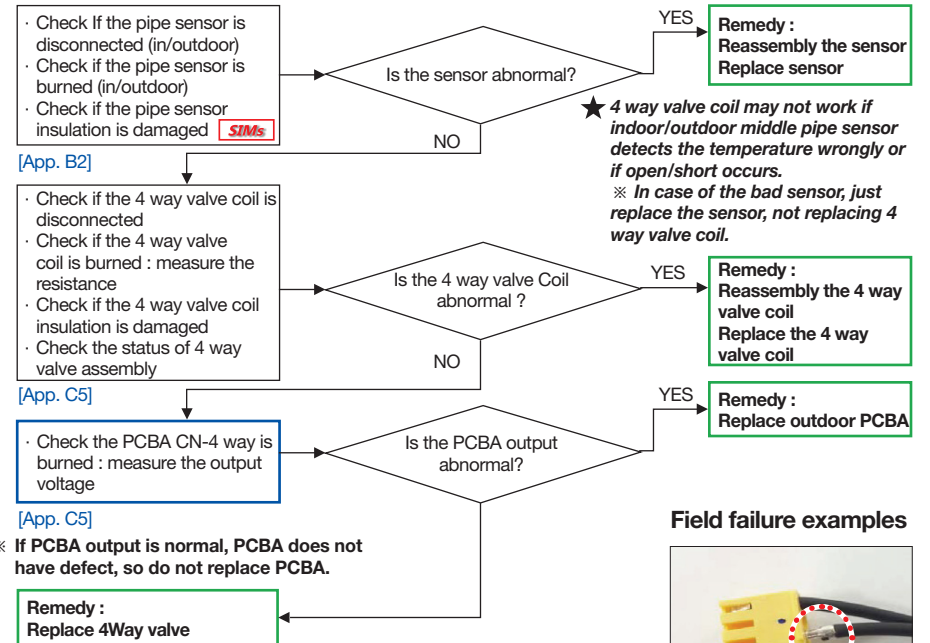

★ 4 way valve coil may not work if indoor/outdoor middle pipe sensor detects the temperature wrongly or if open/short occurs.
※ In case of the bad sensor, just replace the sensor, not replacing 4 way valve coil.

Field failure examples

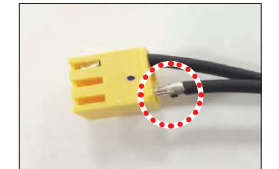

※ If PCBA output is normal, PCBA does not have defect, so do not replace PCBA.

Remedy : Replace 4Way valve

※ Parts Replacement Procedure(Recommended)



4. Appendix A (Installation)

4. Appendix A (Installation)

A1. Installation location

■ A1-1 Check indoor unit location (1)

How?

- Make sure there is no heat or steam around indoor unit.
- Make sure heat radiation from condenser is not blocked.
- Place where noise & vibration are minimum.

Why?

- Reduce cooling capacity.
- Cause low performance.
- Prevent noise problem.

Indoor Unit Space Requirement :

Unit : mm

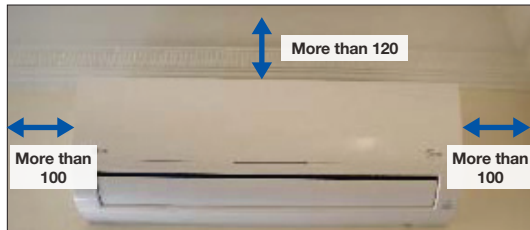

Tips :

- Where inlet/outlet airflow is not blocked.
 - Low cooling performance.
- Always follow the space requirements to prevent such cases.
- Consider safety, servicing space when selecting installation place.

Case of field defect (a)

- Improper unit installation place
 - Difficult when servicing



■ A1-1 Check indoor unit location (2)

Case of field defect (b)

- Inlet airflow to evaporator is blocked
 - Product low cooling / heating
 - Noise might occur

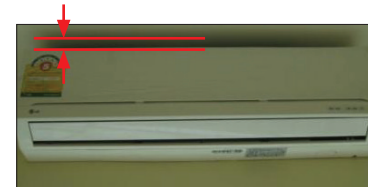

Case of field defect (c)

- Indoor unit is installed too high
 - Discharge air can't be fully distributed to user.
 - Low cooling / heating

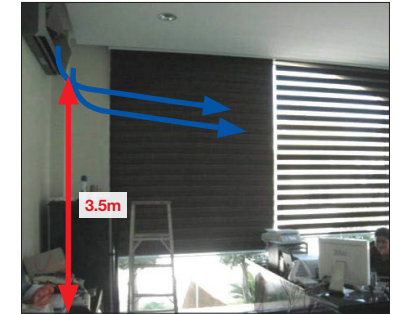

Case of field defect (d)

- Improper unit installation place.
 - Safety issues



4. Appendix A (Installation)

■ A1-2 Check outdoor unit location (1)

Outdoor Unit Space Requirement :

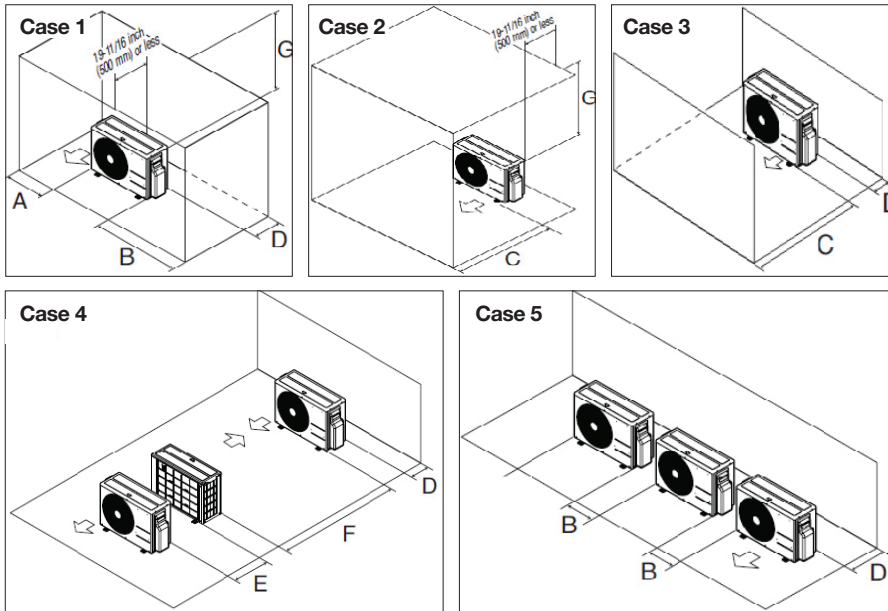

Unit : mm (inch)

		A	B	C	D	E	F	G
Case1	Normal	300 (11-13/16)	700 (23-19/32)	-	300 (11-13/16)	-	-	-
	Min.	100 (3-15/16)	250 (9-27/32)	-	100 (3-15/16)	-	-	1000 (39-3/8)
Case2	Normal	-	-	500 (19-11/16)	-	-	-	-
	Min.	-	-	350 (13-25/32)	-	-	-	1000 (39-3/8)
Case3	Normal	-	-	500 (19-11/16)	300 (11-13/16)	-	-	-
	Min.	-	-	350 (13-25/32)	100 (3-15/16)	-	-	-
Case4	Normal	-	-	-	300 (11-13/16)	600 (23-19/32)	2000 (78-3/4)	-
	Min.	-	-	-	100 (3-15/16)	200 (7-7/8)	-	-
Case5	Normal	-	700 (23-19/32)	-	300 (11-13/16)	-	-	-
	Min.	-	250 (9-27/32)	-	100 (3-15/16)	-	-	-

■ A1-2 Check outdoor unit location (2)

Tips :

- When installing the unit at a high place be sure to fix the unit legs. (safety precautions)
- Consider enough space for service when installing outdoor unit.
- Avoid small installation places as possible.
- Always follow the given space requirement when selecting install location.

Case of field defect (a)

- Outdoor unit is installed on top of each other without safely anchoring the unit.
 - Noise/vibration
 - Hard to service
 - Safety issues



4. Appendix A (Installation)

■ A1-2 Check outdoor unit location (3)

Case of field defect (b)

- Hot discharge air will enter the unit cause a work overload and start ON/OFF system.
 - Low performance

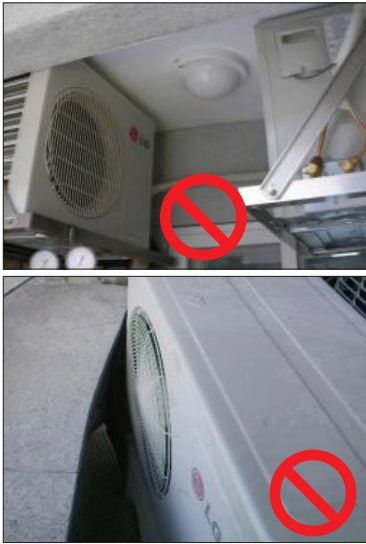

Case of field defect (c)

- Inlet airflow to condenser is blocked
 - Operating pressure will be high and the unit may repeatedly on-off resulting low cooling/heating



A2. Piping Work

■ A2-1 Check Piping Connection (1)

How?

- Make sure that the flare do not have any scar or dust, etc.
- Make sure to follow the given applied torque.

Why?

Prevent strange material from entering system. If applied torque is too strong, flare will get damaged.

Flaring Position :

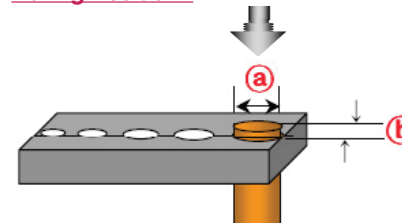

a) Outside diameter		b) A		Thickness
mm	inch	mm	mm	mm
Ø6.35	1/4"	1.1 ~ 1.3	0.7	
Ø9.52	3/8"	1.5 ~ 1.7	0.8	
Ø12.7	1/2"	1.6 ~ 1.8	0.8	
Ø15.88	5/8"	1.6 ~ 1.8	1	
Ø19.05	3/4"	1.9 ~ 2.1	1	

• Checking Flare Work

- Compare the flaring work with the figure.
- If a flaring section is defective, cut it off and do flaring work again.

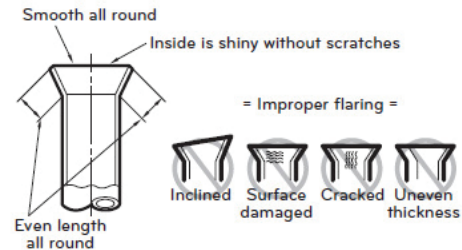

Case of field defect

- Improper flaring
 - Gas leakage



4. Appendix A (Installation)

■ A2-1 Check Piping Connection (2)

Piping connection :

- Align the center of the pipes and sufficiently tighten the flare nut by hand.
- Finally, tighten the flare nut with torque wrench until the wrench clicks.

Outside diameter		Torque	
mm	inch	kgf-cm	N-m
Ø6.35	1/4"	180 ~ 250	17.6 ~ 24.5
Ø9.52	3/8"	340 ~ 420	33.3 ~ 41.2
Ø12.7	1/2"	550 ~ 660	53.9 ~ 64.7
Ø15.88	5/8"	630 ~ 820	61.7 ~ 80.4
Ø19.05	3/4"	990 ~ 1210	97.0 ~ 118.6

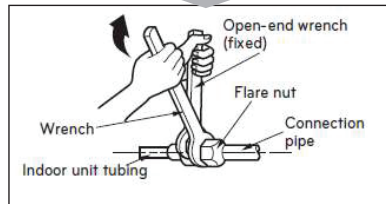
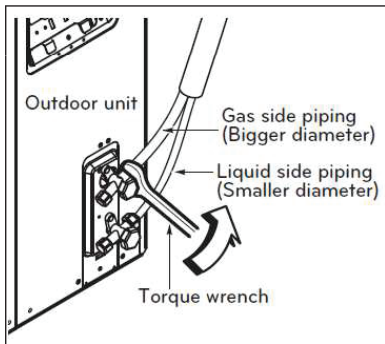
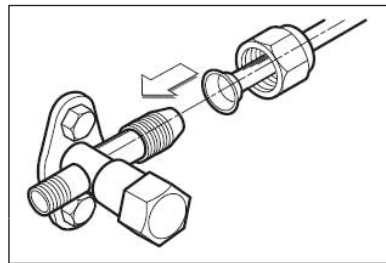
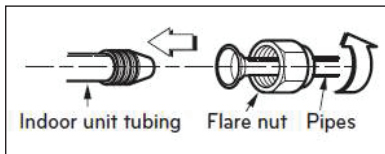

Case of field defect

- Applied torque is too strong flare will get damaged.
 - Gas leakage



■ A2-1 Check Piping Connection (3)

Bending pipe :

- Do not bend the pipe more than 2 times and work in large radius.
- If the pipe is bent, the cooling / heating capacity may deteriorate and cause a leakage problem.
- For aluminum pipe, be careful not to cause a crack on the part where the aluminum and copper are joined.

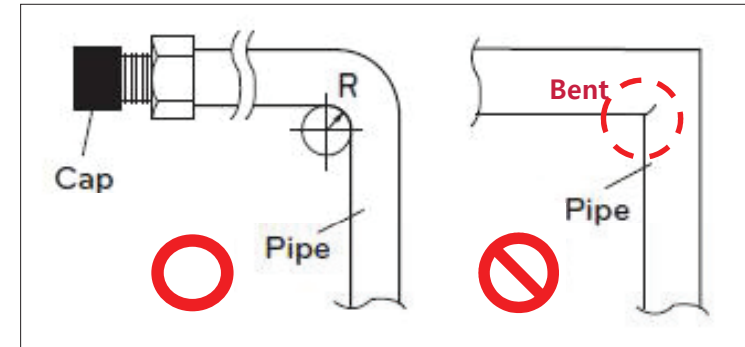

Case of field defect

- Damage during pipe bending work.
 - Clogged refrigerant cycle



4. Appendix A (Installation)

■ A2-2 Check welding(brazing) work

How?

- Nitrogen should be allowed to flow without building up a pressure in the pipeline.
- Brazing requires sophisticated techniques, it must be preformed by qualified person.

Why?

Prevent from carbon scales clogging. Safety precautions and to make sure the work is done properly without any leakage.

Brazing with Nitrogen :

- Connect a nitrogen cylinder to one end of the pipe work.
- Turn on the gas and regulate the flow.
 - 0.1 ~ 0.2 kgf/cm² (1.4 ~ 2.8 psi)
- Continue the flow until the joints have cooled.

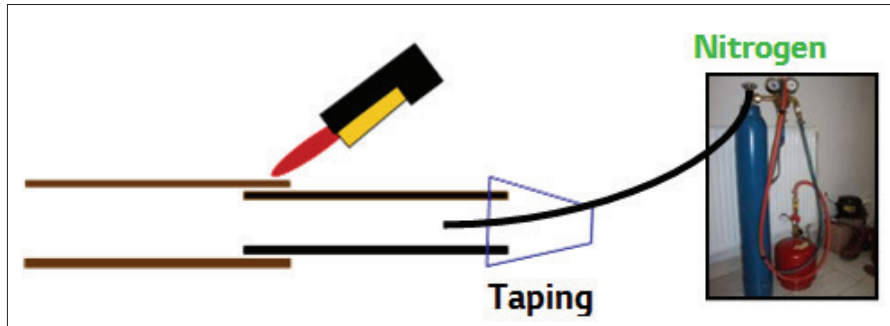

Case of field defect

- Brazing without Nitrogen release.
 - Troubles during circulation in a cycle, like clogging EEV / Compressor / Pipe.



A3. Electric wiring work

■ A3-1 Check Wire Specification

How?

- Always follow the wiring & circuit breaker spec.
- Additional Earth Leakage Circuit Breaker for inverter product is highly recommended.

Why?

Cause abnormal heat / terminal overheating. Product earth leak detector malfunction.

Wire & Circuit Breaker Selection :

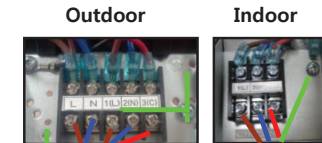
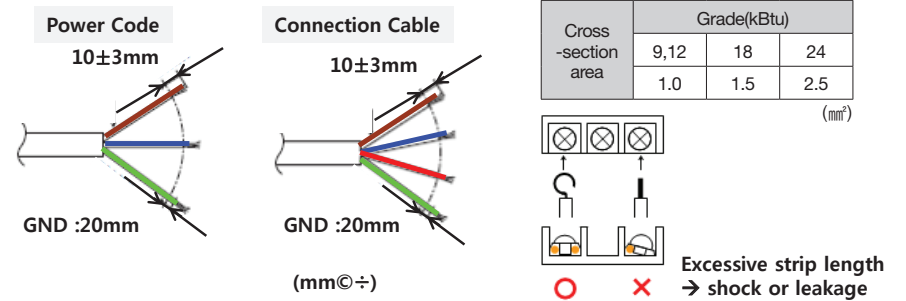

*ELB : Earth Leakage Breaker

Circuit Breaker	Grade(kBtu)		
	9,12	18	24
15	20	30	

(A)

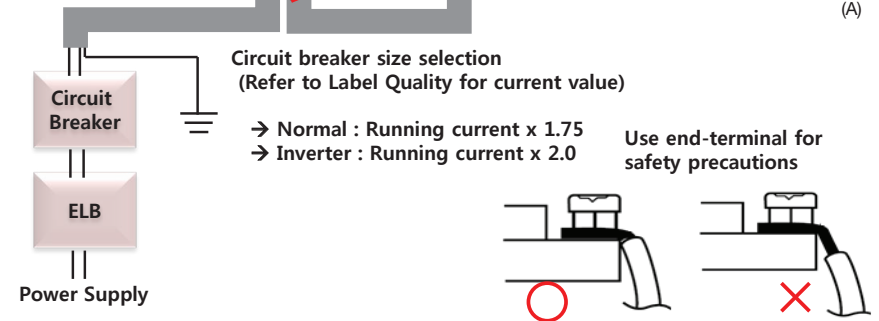

4. Appendix A (Installation)

■ A3-2 Check Wiring connection (1)

How?

- Connect the wires between indoor & outdoor units so that the terminal numbers and colors are matched.
- Tighten the terminal screws securely.
- Do not extend cable connections.

Why?

- If the wires are not matched, communication error will occur
- If the connection is loosen, electric shock may occur.
- Extending cable will create noise or electric

Indoor Power Supplied Type



Connection cable

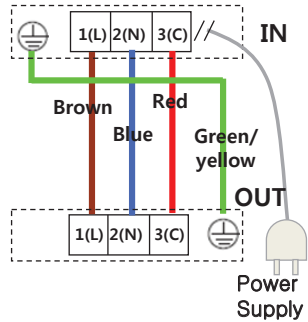
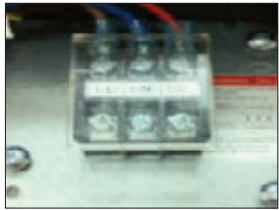

Outdoor Power Supplied Type



Connection cable

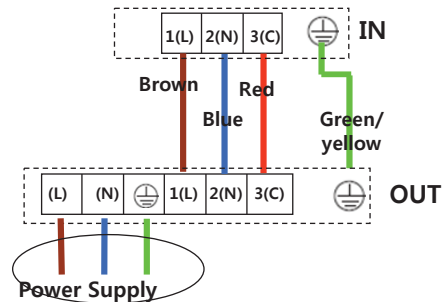
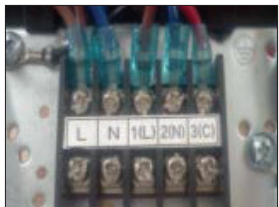

■ A3-2 Check Wiring connection (2)

Case of field defect (a)

- Improper power supply wiring / absent ground wire
 - Heat ignition of terminal block can cause fire.
 - Electric shock

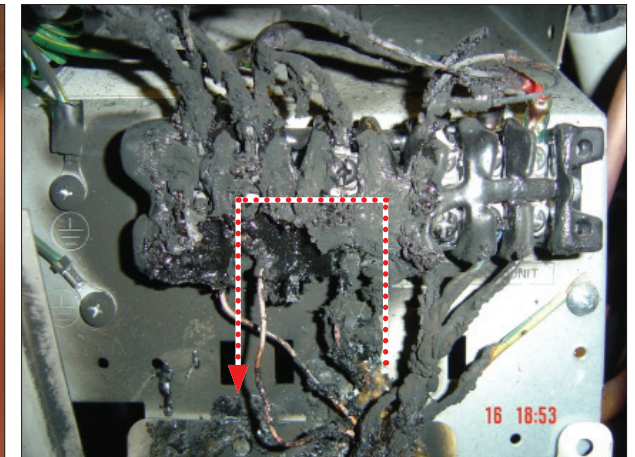

4. Appendix A (Installation)

■ A3-2 Check Wiring connection (3)

Case of field defect (b)

- Improper extended wiring connection
 - Cable over heat or fire might occur
 - communication Error CH05/53 occur (operating stop)



Tips :

Extending electric wire:

1st layer of insulation :
Make sure to solder the wires to reduce the contact resistance and by using thermal contraction tube.

2nd layer of insulation :
Wrap the connection with insulation tape to prevent exposure to moisture/surrounding

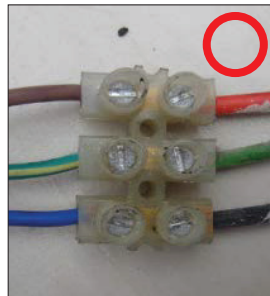

A4. Insulation & Drain Work

■ A4-1 Standard insulation work (1)

How?

- Do the insulation after leak test is done.
- Bundle the pipe and drain hose together with vinyl tape.

Why?

Prevent possible water leakage.

Work Process :

Wrap together refrigerant piping, cable and drain hose with vinyl tape.

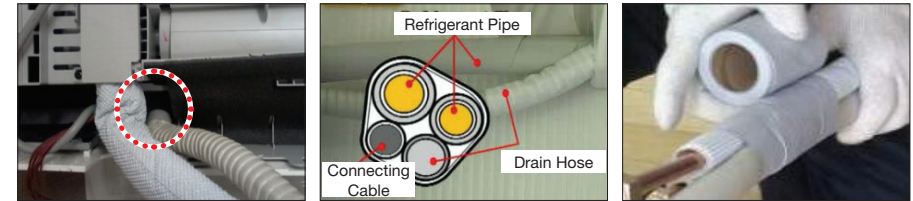

Caution : Set the tubing line upward → prevent possible water leakage.

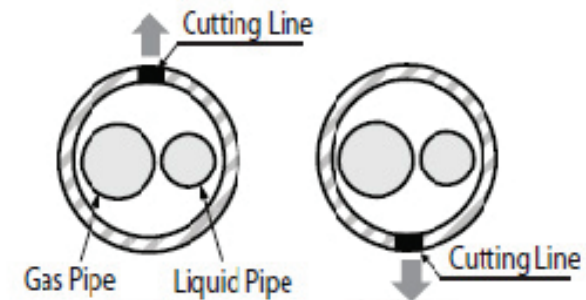
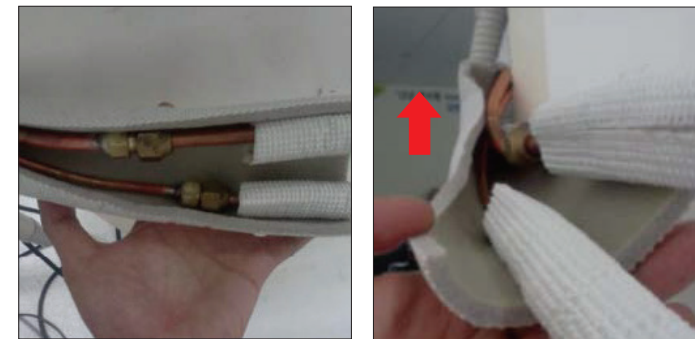

4. Appendix A (Installation)

■ A4-1 Standard insulation work (2)

Tips :

- Fully insulate the connection part between indoor drain hose & extension hose.
- If not leakage may occur as the water will condensate due to temperature changes.
- Slightly slanted to outdoor side. → Ensure water properly flow in downward direction.

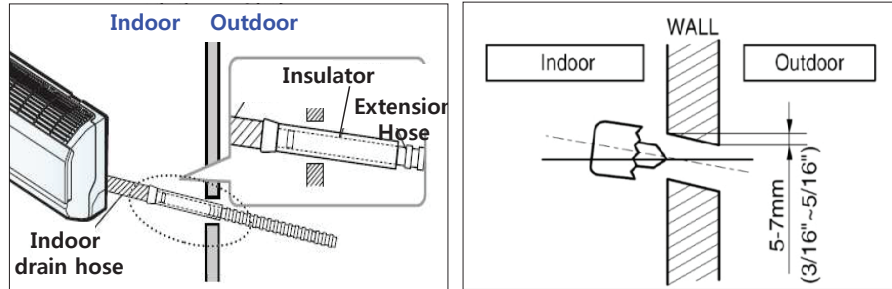

Case of field defect :

- Water leakage at pipe connection due to bad insulation.
 - Mold gather at the wall.

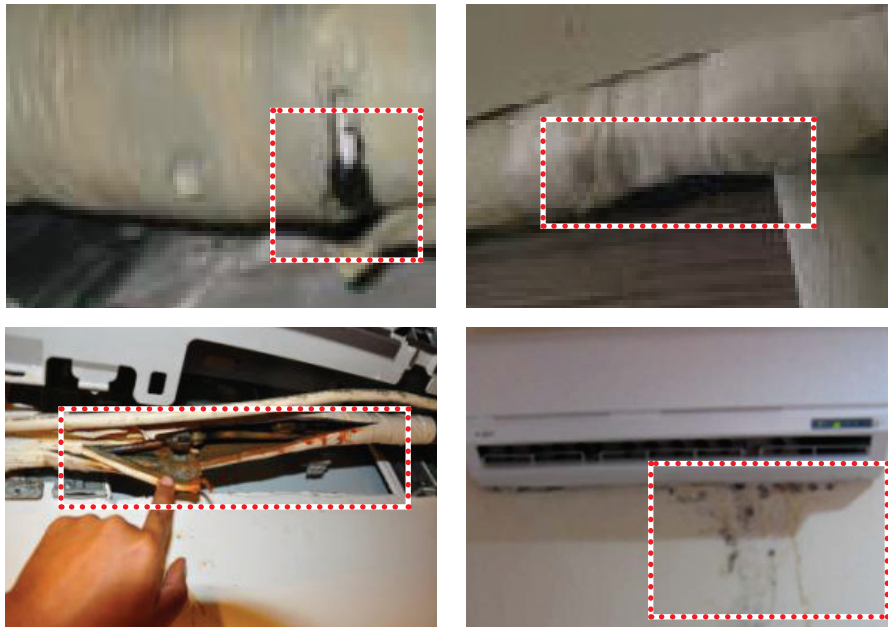

■ A4-2 Water Leak Test (1)

How?

- Pour a water to make sure well drainage.
- Make sure the route of drainage is done properly

Why?

- Prevent water leakage during operation.
- If the drain hose curled, water leakage occurs.

Checking Drainage :

Pour a glass of water onto evaporator

Check possible leakage

Ensure water flows out the drain exit without leakage

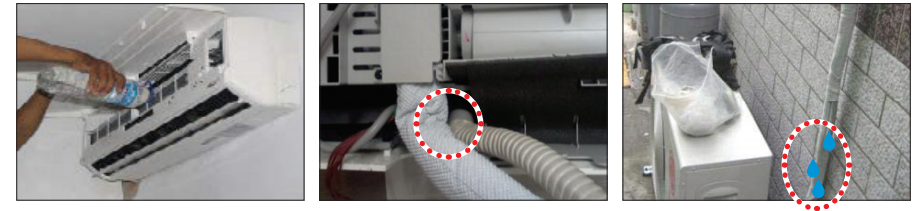

Tips :

- The drain hose should point downward for easy drain flow
- warp the area which accommodates the refrigerant piping, electric cable, drain hose with vinyl tape in Bottom-up direction.
- Fix drain hose to prevent bending or curling
- Drain hose connection must be easy accessible & serviceable.
- For every 1 m (3 ft), fix the drain pipe with clip/tie wrap.

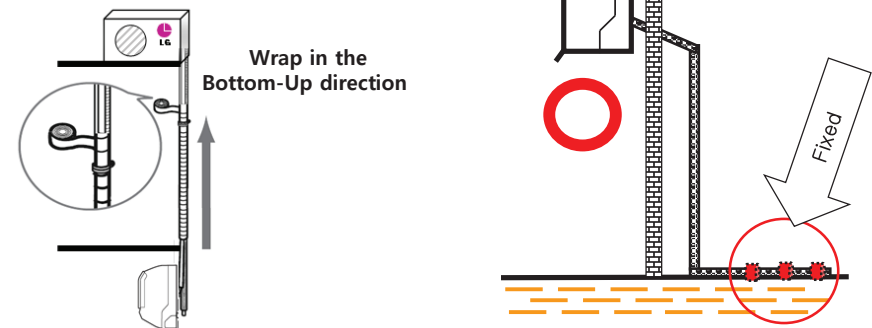

4. Appendix A (Installation)

■ A4-2 Water Leak Test (2)

Case of field defect :

- Drain hose is in upward slanted direction.
— Drain water can not flow to outdoor unit.
- Curled drain hose will block water flow.
— Water leaks at indoor unit.
- Vinyl tape has to be wrapped from bottom to the top.
— Prevent possible leakage to indoor when raining.



■ A4-2 Water Leak Test (3)

Caution of Drain work:



Case 1 : Indoor drain hose is high more than outdoor.



Case 2 : Installing without rain traps



Case 3 : The end of the drain hose plugged into a bottle.

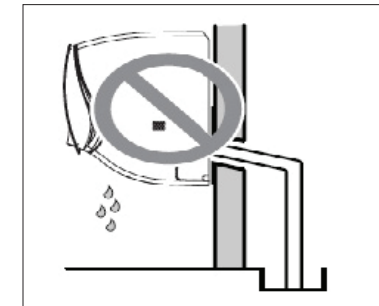

Case 4 : When the end of the drain hose is locked in the sewer.



Case 5 : The end of the drain hose is locked into the water.



Case 6 : The end of drain hose is curled up.

4. Appendix A (Installation)

■ A4-2 Water Leak Test (4)

Caution of Drain work:

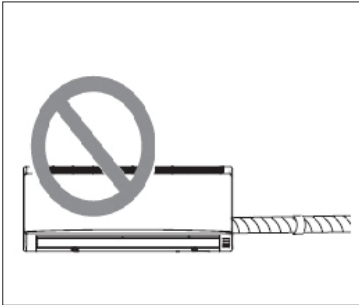

Case 7 : When the drain hose is installed in more than 2m horizontally.



Case 8 : When the end of the drain hose abuts narrow the gap with the ground.

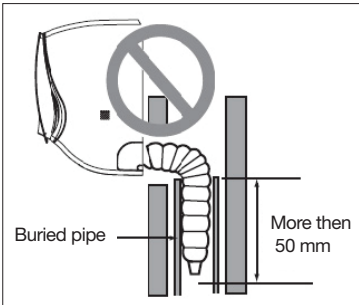

Case 9 : When drain hose is not inserted at least 50mm into the buried pipe

A5. Vacuum

■ A5-1 Gas Leak Test (1)

How?

- Top of nitrogen cylinder must be higher than its bottom.
- Use soap bubble to identify the location of leak. (Bubble indicates gas leak)

Why?

To avoid liquid state nitrogen from entering the system. Insufficient gas will reduce the cooling capacity.

Work Process : Leak Test

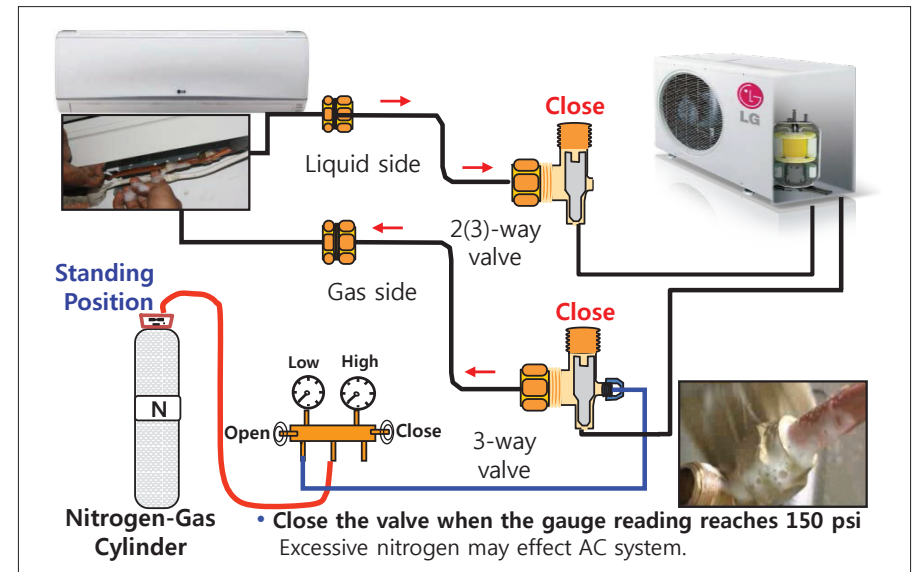

※ Gas Leak Test with nitrogen Process

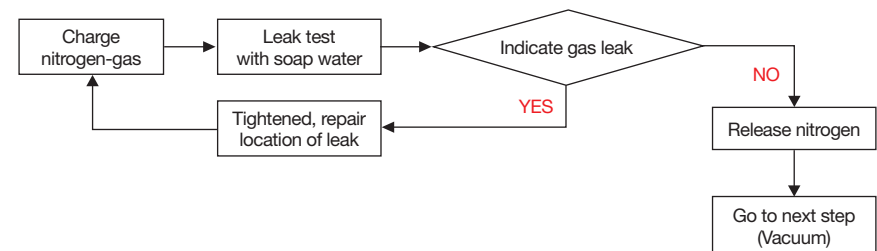

4. Appendix A (Installation)

■ A5-2 Vacuum work process (1)

How?

- Air evacuation with vacuum pump is a must.
- Liquid and the gas side **SVC valves are kept closed**.

Why?

- Air and moisture in system have bad effects as :
 - Pressure in the system rises.
 - Cooling / heating efficiency drops.

Work Process : A NEW Product

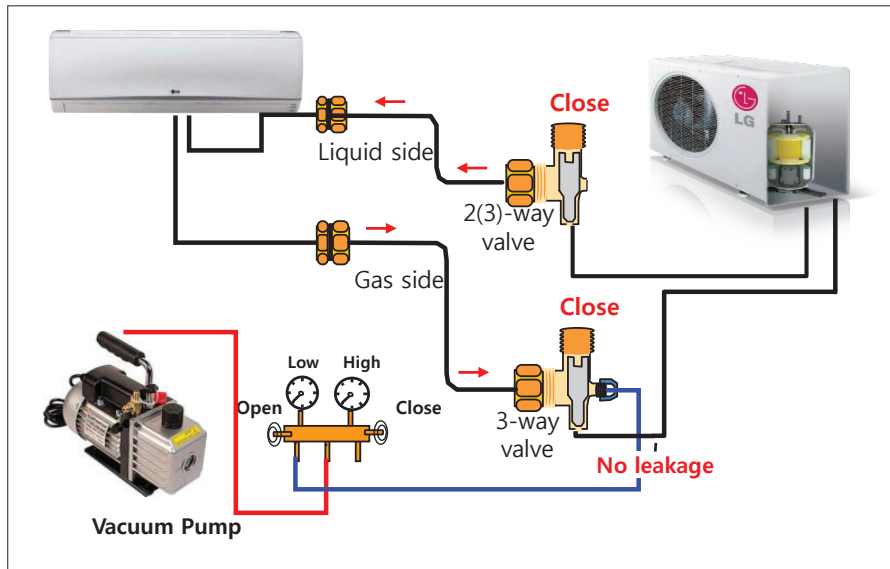

※ Vacuum work Process (A NEW Product)

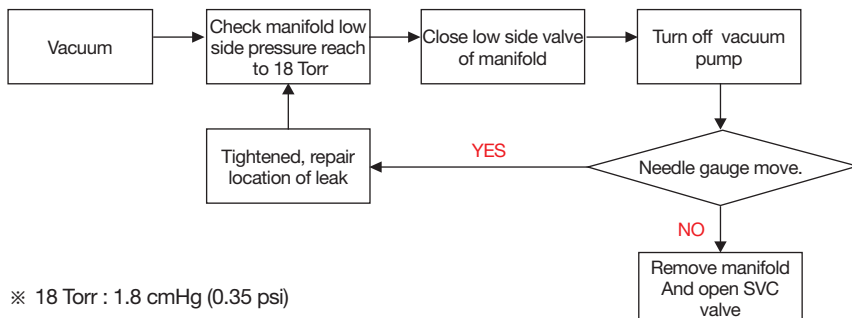

※ 18 Torr : 1.8 cmHg (0.35 psi)

■ A5-2 Vacuum work process (2)

How?

- Air evacuation with vacuum pump is a must.
- Liquid and the gas side **SVC valves are must open**.

Why?

- Air and moisture in system have bad effects as :
 - Pressure in the system rises.
 - Cooling / heating efficiency drops.

Work Process : Vacuum work when recharging refrigerant

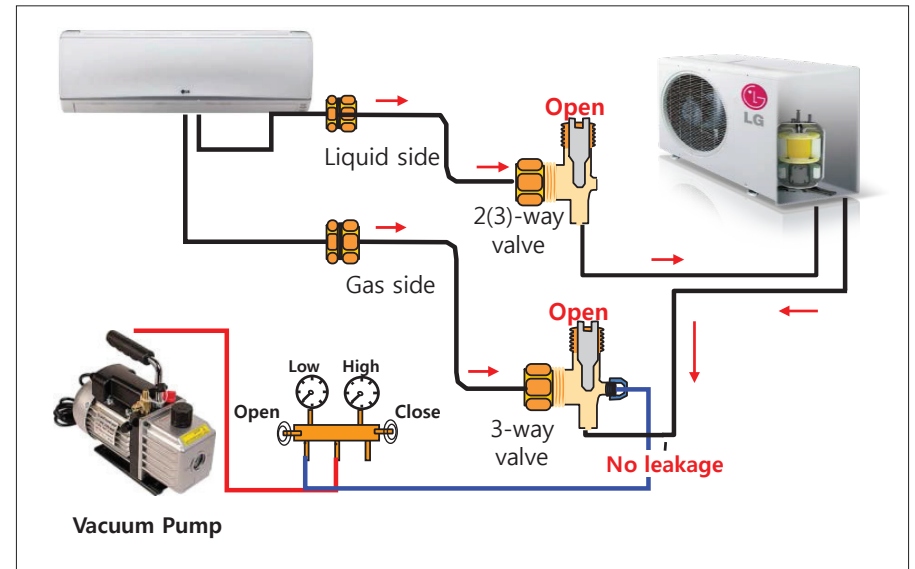

※ Vacuum work Process (When recharging refrigerant)

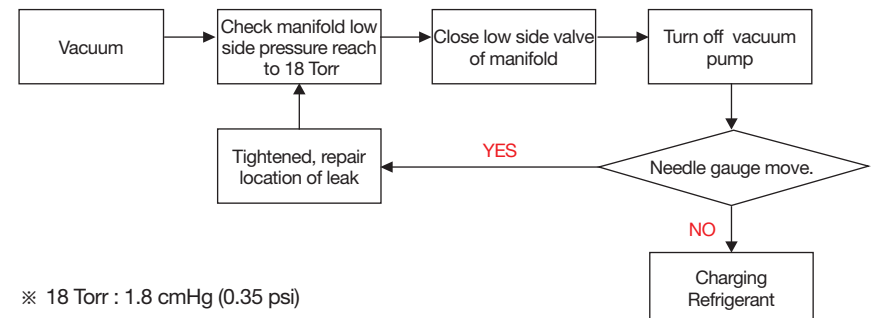

※ 18 Torr : 1.8 cmHg (0.35 psi)

4. Appendix A (Installation)

■ A5-3 Additional Charge Refrigerant

How?

- Charge in standing upright position.

Why?

- Charging R410A must be liquid state for right composition
- Effect such as low cooling.

Work Process : Additional charge refrigerant

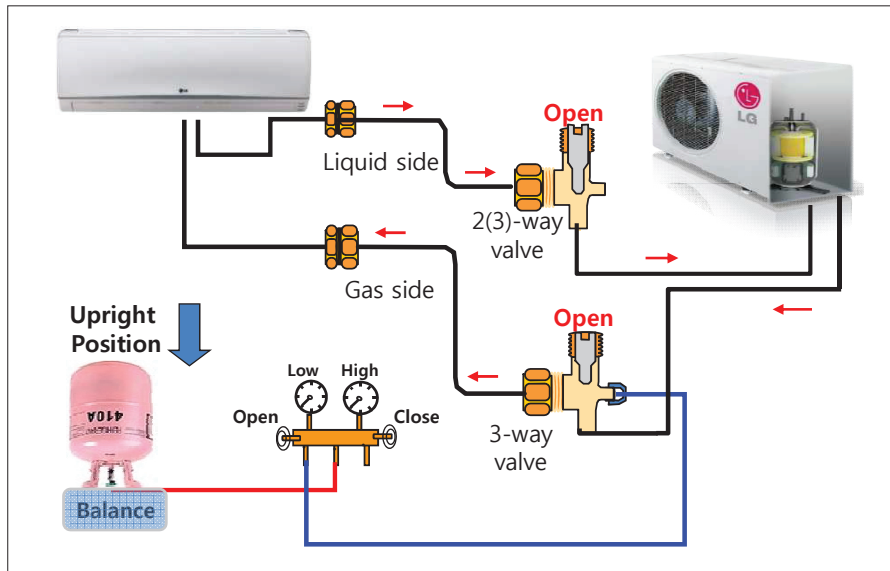

※ charging work Process (when recharging refrigerant)

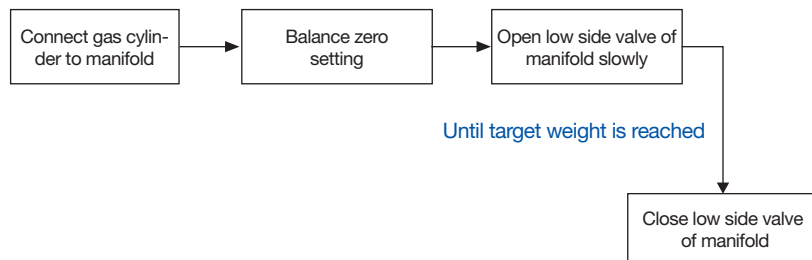

A6. Test Run SIMS

■ A6-1 How to operating

How?

- Press On/Off button(on the indoor product) and hold 3 ~ 6 sec.
- Press On/Off button(on the remote control) with Temp v button and hold 3 sec.
- Check operating temperature, pressure, current, voltage etc.

Why?

To enter a mode is specially designed for test run. Ensure the product work properly or not

Test Run Operating Logic :

- In this mode, regardless of the outside temperature, the unit will operate for 18 ± 1 minute in below conditions :
 - Cooling mode
 - Thermal On/Comp On
 - Comp. fixed frequency
 - Indoor fan speed high
 - Vertical auto swing airflow



- Wireless remote control

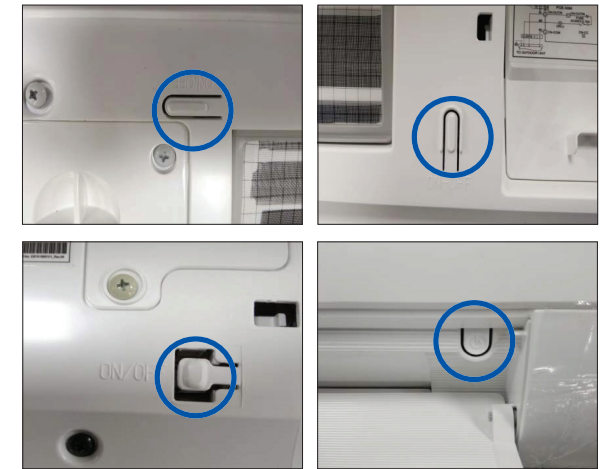

- Knob switch on the indoor unit

4. Appendix A (Installation)

■ A6-2 Check item (1)

Check Items (a):

- Measure the temperature of the intake & discharge air.



※ Ensure the difference between the intake & discharge temp. is more than 8°C (Cooling) & 14°C(Heating)

Check Items (b):

- Measure the pressure of the gas side service valve.

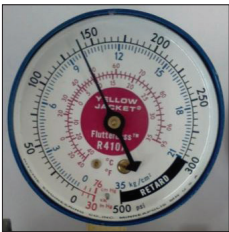

Ref.	Outside ambient TEMP	Pressure of the gas Side Service valve.
R410A	35°C(95°F)	9.5 ± 3 kg/cm ² G (135 ± 43 P.S.I.G)

※ If the pressure is drop or significantly higher than specification:



Pressure is low:
Gas leakage / insufficient

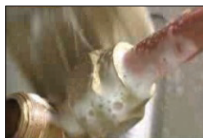

Pressure is high:
System is overloaded
Possibility of overcharge
Closed SVC valve recheck

■ A6-2 Check item (2)

Check Items (c):

- Measure the voltage & operating current. (Refer to Label Quality for specification)



※ Power supply voltage/current complied with the rated value

Check Items (d):

Check Items	Symptom
Indoor & Outdoor units are installed on solid bases.	Fall, vibration, noise
System is properly ground to earth	Electrical leakage
Wiring connection	Inoperative or error code 05
Drain line is properly installed	Water leakage

4. Appendix B (LG SIMs)

4. Appendix B (LG SIMs)

B1. How to use LG SIMs 2.0

B1-1 LG SIMs 2.0 (Wi-Fi)/ Specification

※ If engineer use the LG SIMs for check the unit operation during Installation & SVC.
So that Installer & SVC engineer can correct diagnosis

Specification

- Name : LG SIMs 2.0 (Wi-Fi)
 - LG Smart phone Inverter Monitoring System
- Accessory : SIMs Wi-Fi module
- Connection
 - LG SIMs 2.0 connect with LGMV cable in ODU
 - Operate LGSIMS app, in Smart phone.
 - ※ Wi-Fi Connection Name is LGE_MV-XX-XX-XX

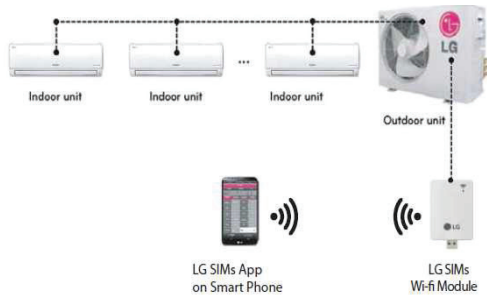

[SIMs 2.0 to typical DFS System]

- Operation OS
 - ※ SIMs 2.0 is not optimized for tablets.

Smart phone supporting specifications				Wireless communication effective distance
OS	Minimum Specification	Recommended Specification	Resolution	
iOS	iOS 6.1	iOS 6.1 / 7.0 / 8.0	960x640 / 1136x640 / 1334x750 / 1920x1080	<ul style="list-style-type: none"> • Effective Distance : 10 m(Open area) • The effective distance may be reduced by the communication environment
Android	Android 2.3	Android 4.4	480x800 / 720x1280 / 7680x1280 / 768x1024 / 1080x1920	

Connection



[Smart LGMV Wi-Fi Module]



B1-2 LG SIMs 2.0 (Wi-Fi)/ Main Information (1)

Initial setup



[Main Info]

- ① Tap the start button and SIMs2.0 will begin to scan for active Wi-Fi devices in the area. Tap the SIMs2.0 Wi-Fi in the list to connect to the Wi-Fi module. Press the OK button and the main info screen displays.

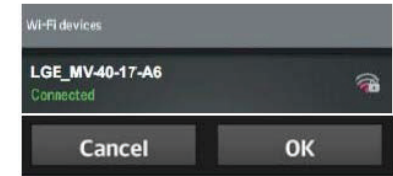

- ② The setting screen displays. You can make selections for language, unit and Demo mode.

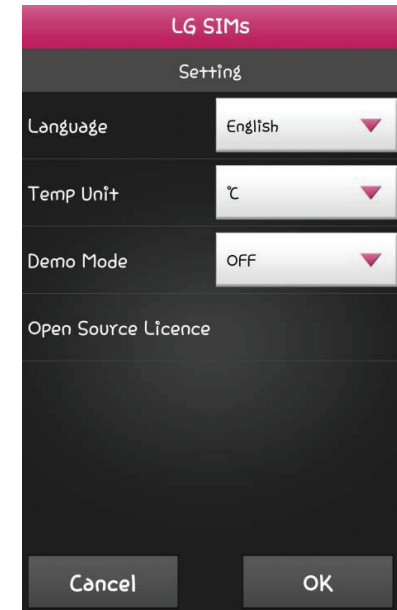

4. Appendix B (LG SIMs)

■ B1-2 LG SIMs 2.0 (Wi-Fi)/ Main Information (2)

After the Wi-Fi is being connected, while the **Main Info** is displayed

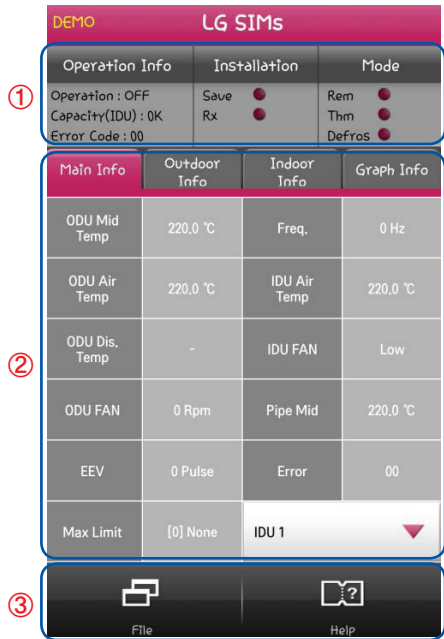

[Main Info]

① Operation information

Item	Description
Operation	ODU operating mode : Cooling / Heating / Fan / Off
Capacity(IDU)	Capacity of the selected indoor unit
Error Code : XX	Current AC system error (If any)
Save	Not used
Rx	When lit, indicates an active wireless connection
Rem	Remote controller is on when lit
Thm	Thermo on when lit
Defrost	System in defrost mode when lit

② Cycle information (on main info tab)

Item	Description
ODU Mid Temp	Outdoor heat exchanger pipe mid. temperature
ODU Air Temp	Outdoor temperature
ODU Dis. Temp	Outdoor unit compressor discharge temperature
ODU FAN	Outdoor unit fan speed in RPM
EEV	Electromnic expansion valve
Max Limit	Inverter compressor frequency restriction
Freq.	Outdoor unit compressor frequency
IDU Air Temp	Indoor temperature
IDU FAN	Indoor unit wind amount
Pipe Mid	Indoor heat exchanger Pipe mid. Temperature
Error	Error Code
IDU 1	Indoor unit 1. Tap to display list of all indoor units. The data SIMs displays is for the indoor unit selected by this button.

③ Help menu

Item	Description
File	Save current cycle data by this button(save only). The contents of files can be accessed by the Factory user.
Help	Tap to display trouble shooting guide

■ B1-2 LG SIMs 2.0 (Wi-Fi)/ Main Information (3)

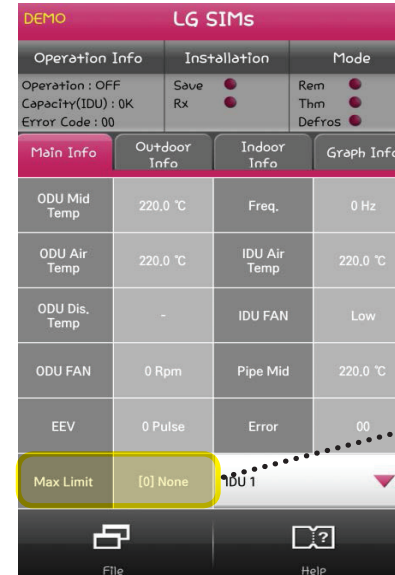

● Max Limit(Protection mode)

Specific wording is displayed in accordance with the operation mode of the product. It means that the protection logic, by which the system operates in the safe range according to the ambient temperature condition and environmental condition, is operating. It is not a failure. The type of the system protection is listed in the following table.

Max. Limit	Description
Tc Limit	Cooling : Outdoor HEX temperature protection mode Heating : Indoor HEX temperature protection mode
Te Limit	Indoor HEX temperature protection mode
Td Limit	Compressor out temperature protection mode
Current Limit	Current protection mode
H/S Limit	Heat-sink temperature protection mode
Air Temp	System protection mode in accordance with the outdoor temperature
Voltage Limit	Voltage protection mode
Dew Limit	Indoor unit Anti-dew protection in operation
Quiet Mode Limit	Quiet mode in operation
Sleep Limit	Sleep mode in operation
Dehumidify Limit	Dehumidification mode in operation

4. Appendix B (LG SIMs)

■ B1-3 LG SIMs 2.0 (Wi-Fi)/ Outdoor Information (1)

Outdoor Unit Information Display

Operation Info		Installation		Mode	
Operation : OFF		Save ●	Rx ●	Rem ●	Thm ●
Capacity(IDU) : 0K				Defros ●	
Error Code : 00					
Main Info	Outdoor Info	Indoor Info	Graph Info		
Component	Temperature				
	Target	Present			
Frequency	0 Hz	0 Hz			
FAN1 RPM	0 Rpm	0 Rpm			
FAN2 RPM	0 Rpm	0 Rpm			
DC Link	0 V	0 V			
Current	0.0A	Restart Timer	0 S		
Voltage	140 V	Comp Mode	Stop		
EEV Mode	0	Main EEV	0 Pulse		

Tap the outdoor info tap to display ODU information. The outdoor info tab has two sub-display, Component and Temperature. Tap the desired one to display its data.

Item	Description
Frequency	Target and present inverter compressor frequency
Fan1 RPM	Target and present fan 1 speed
Fan2 RPM	Target and present fan 2 speed
DC Link	Target and present DC Link voltage
Current	Input current
Voltage	Input voltage
EEV Mode	EEV operation mode
Restart Timer	restart timer
Comp Mode	Compressor operation status
Main EEV	Electronic expansion valve pulse

Operation Info		Installation		Mode	
Operation : OFF		Save ●	Rx ●	Rem ●	Thm ●
Capacity(IDU) : 0K				Defros ●	
Error Code : 00					
Main Info	Outdoor Info	Indoor Info	Graph Info		
Component	Temperature				
	Target	Present			
Inv Td	0.0 °C	0.0 °C			
Suction	-				
Discharge	-				
Cond Mid	220.0 °C				
Cond Out	-				
Heatsink	400.0 °C				
Air Temp	220.0 °C				

Item	Description
Inv Td	Target and present out temperature
Suction	Compressor in temperature
Discharge	Compressor out temperature
Cond Mid	Heat exchanger pipe mid. temperature
Cond Out	Heat exchanger pipe outlet temperature
Heatsink	Heat sink temperature
Air temp	Outdoor temperature

■ B1-3 LG SIMs 2.0 (Wi-Fi)/ Outdoor Information (2)

Operation Info		Installation		Mode	
Operation : OFF		Save ●	Rx ●	Rem ●	Thm ●
Capacity(IDU) : 0K				Defros ●	
Error Code : 00					
Main Info	Outdoor Info	Indoor Info	Graph Info		
Component	Temperature				
	Target	Present			
Frequency	0 Hz	0 Hz			
FAN1 RPM	0 Rpm	0 Rpm			
FAN2 RPM	0 Rpm	0 Rpm			
DC Link	0 V	0 V			
Current	0.0A	Restart Timer	0 S		
Voltage	140 V	Comp Mode	Stop		
EEV Mode	0	Main EEV	0 Pulse		

Compressor operating mode

Comp Mode	Description
Stop	Stop control
Start	Operation control
Steady	On time control
Special	Special control(Defrost operation, Oil recovery operation)

EEV operating mode

EEV Mode	Description
0	EEV Power apply initialization control
1	EEV Start-up initialization control
2	EEV Start-up control mode 1
3	EEV Start-up control mode 2
4	EEV On time control
5	EEV Stop control

4. Appendix B (LG SIMs)

■ B1-4 LG SIMs 2.0 (Wi-Fi)/ Indoor Information

Indoor Unit Information Display

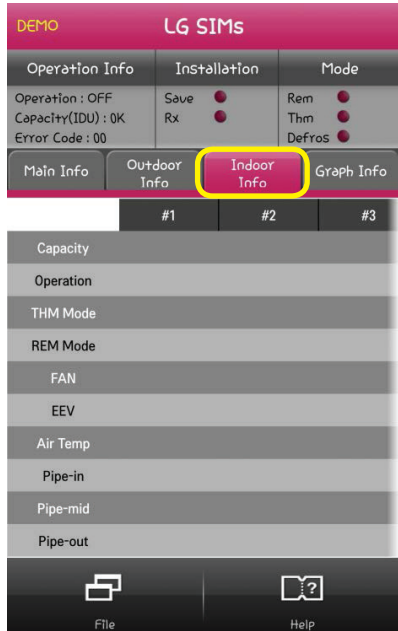

Tap the indoor info tap to display IDU information. Tap the number of the IDU you want to display (#1, #2, etc.). Swipe the number list to the left to display any additional IDU numbers.

Item	Description
Capacity	Indoor unit capacity
Operation	Indoor unit operating mode (cooling/heating)
THM Mode	Thermo on/off
REM Mode	Remote controller on/off
FAN	Fan speed in RPM
EEV	Electronic expansion valve
Air Temp	Indoor temperature
Pipe-in	Heat exchanger pipe inlet temperature
Pipe-mid.	Heat exchanger pipe mid. temperature
Pipe-out	Heat exchanger pipe outlet temperature

■ B1-5 LG SIMs 2.0 (Wi-Fi)/ Graph(Temp & Electronic)

Graph monitoring (IDU Temp)

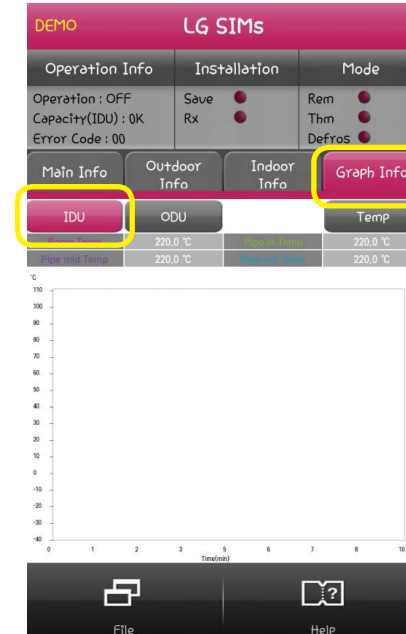

Tap the graph info tab and then tap the IDU tab to display IDU information in graph format. Information displayed is for the IDU # selected on the Main screen. You can “pinch” the screen in and out to change the time scale to display data for a longer or shorter data collection period.

Item	Description
Room Temp	Indoor temperature
Pipe mid. Temp	Heat exchanger pipe mid. temperature
Pipe in Temp	Heat exchanger pipe inlet temperature
Pipe out Temp	Heat exchanger pipe outlet temperature

Allow SIMs to run for 30 to 60 minutes to acquire enough data to show system operating trends.

4. Appendix B (LG SIMs)

■ B1-5 LG SIMs 2.0 (Wi-Fi) / Graph (Temp & Electronic)

Graph monitoring (ODU Temp & Freq.)

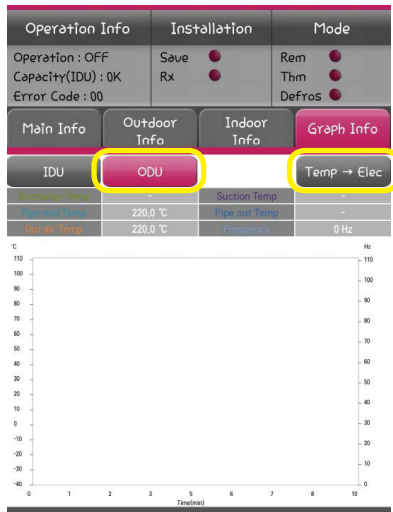

Tap the graph info tab and then tap the ODU tab to display ODU information in graph format. Tap the Temp → Elec. tab / Elec. → Temp tab to switch between ODU temperature and electric data. You can “pinch” the screen in and out to change the time scale to display data for a longer or shorter data collection period.

Item	Description
Discharge Temp	Compressor discharge temperature
Pipe mid. Temp	Outdoor heat exchanger pipe mid. temperature
Out air Temp	Outdoor air temperature
Suction Temp	Compressor inlet temperature
Pipe out Temp	Outdoor heat exchanger outlet temperature
Frequency	Compressor frequency

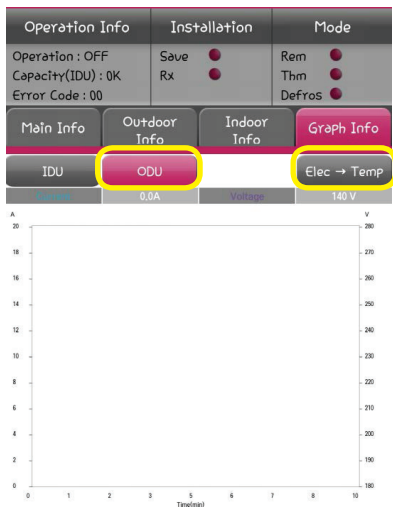

Allow SIMs to run for 30 to 60 minutes to acquire enough data to show system operating trends.

Item	Description
Current	Outdoor unit current
Voltage	Outdoor unit voltage

B2. Basic Checking Guide

■ B2-1 Power Apply Check (1)

※ After installing SIMs 2.0 Module to the product, apply power.

The malfunction of the product may occur without specific Error code Message if the characteristics failure of the electric components happens. By utilizing SIMs 2.0 Module, you can check the operation characteristics of the core electric components in real time and find Service point.

2-1-a Error Code Check

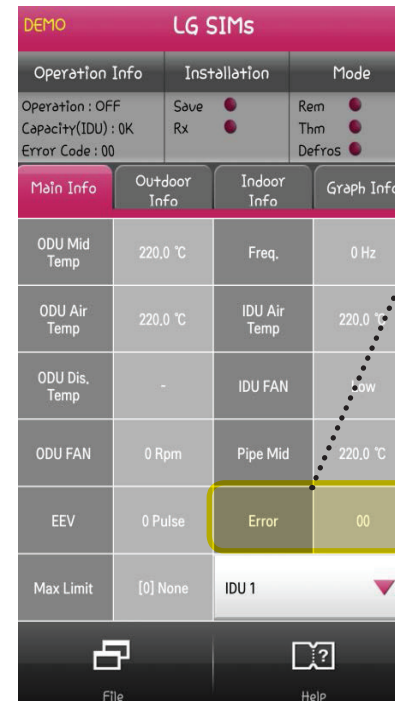

By using SIMs 2.0 Module, the sensor problem due to the characteristics failure as well as Error Code due to the sensor failure can be detected.

● Make sure whether the Error Code is recognized on the Error section at the bottom side of the screen of the SIMs main Info tab.

※ When Error Code occurs, proceed with SVC referring to the corresponding Error Code Trouble shooting guide.

4. Appendix B (LG SIMs)

■ B2-1 Power Apply Check (2)

B2-1-b Check input Voltage

Operation Info		Installation		Mode	
Operation : OFF		Save ●	Rem ●		
Capacity(IDU) : 0K		Rx ●	Thm ●		
Error Code : 00		Defros ●			
Main Info	Outdoor Info	Indoor Info	Graph Info		
Component	Temperature				
	Target	Present			
Frequency	0 Hz	0 Hz			
FAN1 RPM	0 Rpm	0 Rpm			
FAN2 RPM	0 Rpm	0 Rpm			
DC Link	0 V	0 V			
Current	0.0A	Restart Timer	0 S		
Voltage	140 V	Comp Mode	Stop		
EEV Mode	0	Main EEV	0 Pulse		

- Shift to Outdoor info tab and check the voltage status.

In case Input pressure is different with the product Spec.

- Verify the applied voltage of the external power supply
→ Request electric work if the external power supply is faulty
- Check whether the Multi-tap(surge protector, power strip) is used → In case Multi-tap(surge protector, power strip) is used, there is a possibility in malfunction due to the instantaneous over current and over capacity
- Bad power Line wiring

B2-1-c Check Outdoor Unit Temperature

Operation Info		Installation		Mode	
Operation : OFF		Save ●	Rem ●		
Capacity(IDU) : 0K		Rx ●	Thm ●		
Error Code : 00		Defros ●			
Main Info	Outdoor Info	Indoor Info	Graph Info		
Component	Temperature				
	Target	Present			
Inv Td	0.0 °C	0.0 °C			
Suction	-	-			
Discharge	-	-			
Cond Mid	220.0 °C	-			
Cond Out	-	-			
Heatsink	400.0 °C	-			
Air Temp	220.0 °C	-			

- Shift to Temperature tap and verify whether the temperature of the outdoor temperature sensor stays within the normal range.

- In case the characteristics failure of the temperature sensor occurs, it does Sensing more than 10 ° high or low compared to the indoor/outdoor temperature.
- Provided, as the sensing temperature can vary due to the residual heat of the product inside according to the operation mode of the product before inspection, verify after 2hours elapse from the product Off.
- ※ In case of the on-site service, if the product is under the operation or if the product was off within 2 hours, follow B2-2 product operation Check guide.
- ※ If the corresponding temperature information can not be checked(in case it is displayed as " - "), judge it as Open/Short and proceed with SVC.
- ※ As there exists some product not equipped with the specific sensor for each product, verify the SVC Manual of the served product and judge it.

B2-1-d Check Indoor Unit Temperature

Operation Info		Installation		Mode	
Operation : OFF		Save ●	Rem ●		
Capacity(IDU) : 0K		Rx ●	Thm ●		
Error Code : 00		Defros ●			
Main Info	Outdoor Info	Indoor Info	Graph Info		
	#1	#2	#3		
Capacity					
Operation					
THM Mode					
REM Mode					
FAN					
EEV					
Air Temp					
Pipe-in					
Pipe-mid					
Pipe-out					

- Shift to Indoor tap and verify whether the temperature of the indoor temperature sensor stays within the normal range.

- In case the characteristics failure of the temperature sensor occurs, it does Sensing more than 10 ° high or low compared to the indoor/outdoor temperature.

- Provided, as the sensing temperature can vary due to the residual heat of the product inside according to the operation mode of the product before inspection, verify after 1hour elapse from the product Off.

※ In case of the on-site service, if the product is under the operation or if the product was off within 2 hours, follow B2-2 product operation Check guide.
(For fast convergence of the temperature of the indoor unit, perform inspection 1 hour after operating blower mode for 15minutes after product shutdown.)

※ If the corresponding temperature information can not be checked(in case it is displayed as " _ "), judge it as Open/Short and proceed with SVC.

※ As there exists some product not equipped with the specific sensor for each product, verify the SVC Manual of the served product and judge it.

4. Appendix B (LG SIMs)

■ B2-2 Product operation Check

B2-2-a Check DC Link Voltage

Operation Info		Installation		Mode	
Operation : OFF		Save	Rx	Rem	Thm
Capacity(IDU) : 0K				Thm	Defros
Error Code : 00				Defros	
Main Info	Outdoor Info	Indoor Info	Graph Info		
Component	Temperature				
	Target	Present			
Frequency	0 Hz	0 Hz			
FAN1 RPM	0 Rpm	0 Rpm			
FAN2 RPM	0 Rpm	0 Rpm			
DC Link	0 V	0 V			
Current	0.0A	Restart Timer	0 S		
Voltage	140 V	Comp Mode	Stop		
EEV Mode	0	Main EEV	0 Pulse		

- Shift to Outdoor tap and check the status of the DC Link voltage.

- If the DC Link voltage is lower or higher than the Target, malfunction symptom may occur, so it needs confirmation.
- If DC Link problem occurs, shift to Error Code CH23 Page and follow the measures.

B2-2-b Check Outdoor Unit Temperature

Operation Info		Installation		Mode	
Operation : OFF		Save	Rx	Rem	Thm
Capacity(IDU) : 0K				Thm	Defros
Error Code : 00				Defros	
Main Info	Outdoor Info	Indoor Info	Graph Info		
Component	Temperature				
	Target	Present			
Inv Td	0.0 °C	0.0 °C			
Suction	-				
Discharge	-				
Cond Mid	220.0 °C				
Cond Out	-				
Heatsink	400.0 °C				
Air Temp	220.0 °C				

- Shift to Outdoor tap and verify whether the temperature of the outdoor temperature sensor stays within the normal range.

- For the determination of normal cycle, refer to the App. Reference Temperature table. (Sensing temperature of the product varies according to the temperature condition of each outdoor air temperature. Therefore, the standard temperature based on the outdoor/indoor temperature condition is needed in order to determine the normality of the product operation cycle.)

- ※ The sensing temperature in the initial start-up product shows rapid change(Ramp up), it is difficult to judge for the normal(Steady) Cycle. Therefore, in case of the product operation, judge for the sensing temperature after around 20 minutes considering the stabilization period.

B2-2-c Check Outdoor Unit Temperature

Operation Info		Installation		Mode	
Operation : OFF		Save	Rx	Rem	Thm
Capacity(IDU) : 0K				Thm	Defros
Error Code : 00				Defros	
Main Info	Outdoor Info	Indoor Info	Graph Info		
	#1	#2	#3		
Capacity					
Operation					
THM Mode					
REM Mode					
FAN					
EEV					
Air Temp					
Pipe-in					
Pipe-mid					
Pipe-out					

- Shift to outdoor tap and verify whether the temperature of the outdoor temperature sensor stays within the normal range.

- For the determination of normal cycle, refer to the App. Reference Temperature table (Sensing temperature of the product varies according to the temperature condition of each outdoor air temperature. Therefore, the standard temperature based on the outdoor/indoor temperature condition is needed in order to determine the normality of the product operation cycle.)

- ※ The sensing temperature in the initial start-up product shows rapid change(Ramp up), it is difficult to judge for the normal(Steady) Cycle. Therefore, in case of the product operation, judge for the sensing temperature after around 20 minutes considering the stabilization period.

4. Appendix B (LG SIMs)

B3. Abnormal Case Guide

B3-1 No refrigerant / Bad location of the sensor

※ Guide was made based on the Cooling mode, and Heating mode can be detected with the same principle.

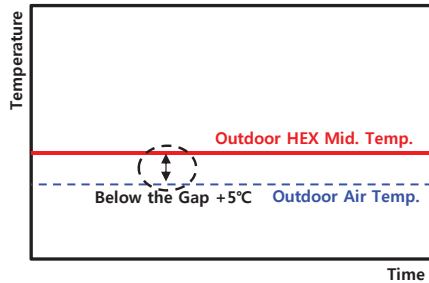

● In case the temperature data of the SIMs graph is similar to the shape of the left graph, there is a possibility in no refrigerant, so leak test should be done.

- When outdoor heat exchanger temperature(ODU MID TEMP) is constantly kept within the gap difference of 'Below +5°C' with outdoor temperature(ODU AIR)
- When indoor heat exchanger temperature(IDU PIPE TEMP) is constantly kept within the gap difference of 'Below +5°C' with indoor temperature(IDU AIR)

※ If above 2 cases are satisfied at the same time, judge that there is no refrigerant inside of the product and perform SVC.

※ If the grape shape of the specific temperature sensor is same to the left, check the position of the sensor(Bad location/Removed)

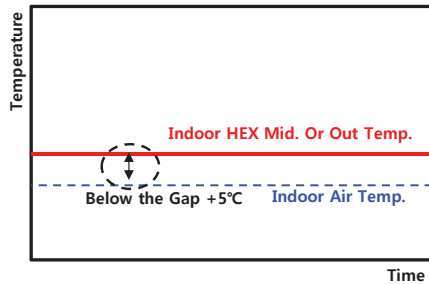

Operation Info	Installation	Mode
Operation : OFF	Save ●	Rem ●
Capacity(IDU) : 0K	Rx ●	Thm ●
Error Code : 00		Defros ●

Main Info	Outdoor Info	Indoor Info	Graph Info
IDU	ODU	Temp	
Indoor Temp	220.0 °C	220.0 °C	220.0 °C
Outdoor Temp	220.0 °C	220.0 °C	220.0 °C

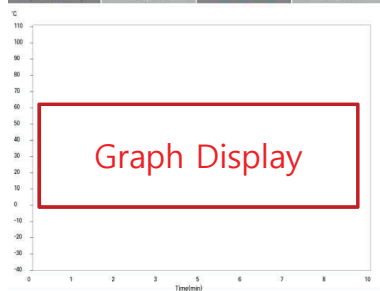

B3-2 Cycle Block (EEV, SVC Valve closed)

※ Guide was made based on the Cooling mode, and Heating mode can be detected with the same principle.

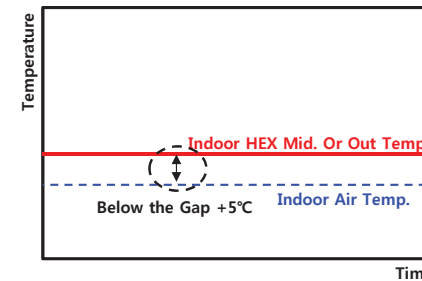
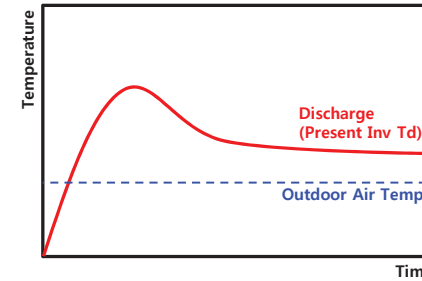
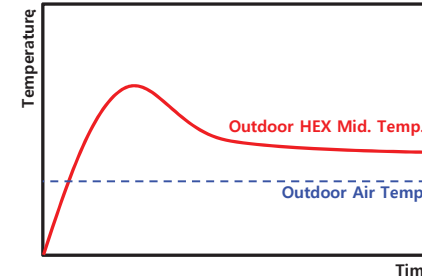

● In case the temperature data on the SIMs graph is similar to the shape of the left graph, Cycle clogging is suspected, so SVC Valve Lock should be checked.

- When outdoor heat exchanger temperature(ODU MID TEMP) approaches the outdoor temperature(ODU AIR) by gradual decrease after increase
- When compressor discharge temperature approaches the outdoor temperature(ODU AIR) by gradual decrease after increase
- When indoor heat exchanger temperature(IDU PIPE TEMP) is constantly kept within the gap difference of 'Below +5°C' with indoor temperature(IDU AIR)

※ If above 3 cases are satisfied at the same time, judge that there is no refrigerant inside of the product and perform SVC.

※ In case of the outdoor temperature sensor graph, it can occur as a phenomenon of the normal control under the condition that Compressor Frequency is changing.

Operation Info	Installation	Mode
Operation : OFF	Save ●	Rem ●
Capacity(IDU) : 0K	Rx ●	Thm ●
Error Code : 00		Defros ●

Main Info	Outdoor Info	Indoor Info	Graph Info
IDU	ODU	Temp	
Indoor Temp	220.0 °C	220.0 °C	220.0 °C
Outdoor Temp	220.0 °C	220.0 °C	220.0 °C

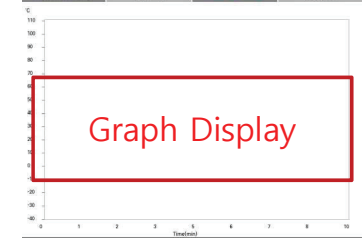

4. Appendix B (LG SIMs)

■ B3-3 Cycle Block (No action of EEV) / Bad location of Td sensor

- No action of EEV(too much open)

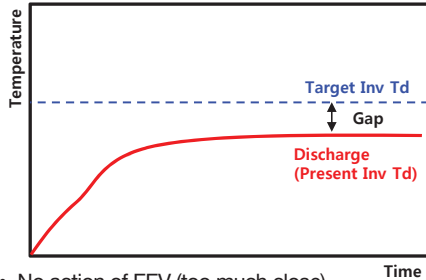

- No action of EEV (too much close)

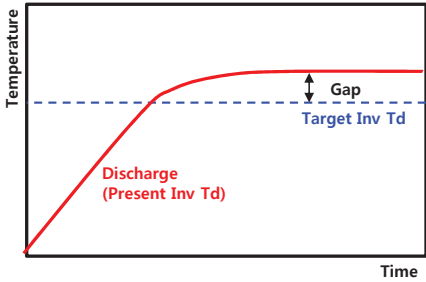

- In case the temperature data on the SIMs graph is similar to the shape of the left graph, judge it as 'No action of EEV' or 'Bad location of Td sensor'.

- When the compressor discharge temperature becomes stabilized under that state of not reaching Target Inv Td (Gap occurs over than 10°C)

- ※ If it is not operated under the state that EEV opening is opened a lot, the same phenomenon may occur.

- ※ If the location of Td sensor is faulty(Removed/Inserted wrongly), the same phenomenon may occur.

- When the compressor discharge temperature becomes stabilized under that state of exceeding Target Inv Td (Gap occurs over than 10°C)

- ※ If it is not operated under the state that EEV opening is opened a little, the same phenomenon may occur.

- Abnormal fastening state of EEV Coil



- Abnormal fastening state of Td sensor



B4. Reference Cycle Temperature Table

■ B4-1. Cooling Mode

Determine the normal temperature range referring to the Reference Cycle data for each indoor/outdoor temperature condition.

- ※ Under the cooling operation mode, Inv.Td should always higher than the temperature of the outdoor pipe. IF Inv.Td temperature is same or lower than the outdoor pipe temperature, the confirmation for the sensor insertion faulty/characteristics faulty is required.

B4-1-a Standard Cooling Temperature : Indoor 27 °C (81 °F) / Outdoor 35 °C (95 °F)
Remote Control Setting : 18°C (34 °F) / High

Capacity (B.T.U)	Tool	Pipe Length (m/ft)	Indoor °C (°F)			Outdoor °C (°F)					kgf/cm ² (psi)	
			HEX In	HEX Mid.	HEX Out	Suction	INV Td	HEX In	HEX Mid.	HEX Out	Pressure High	Pressure Low
			9k	UA3	9.5 (49)	8.9 (48)	10 (50)	10.2 (50)	79.4 (175)	76.4 (170)	49 (120)	40.3 (105)
12k	UA3	10.3 (51)	9.4 (49)	9.1 (48)	8.1 (47)	79.2 (175)	74.6 (166)	47.9 (118)	39.1 (102)	32.3 (459)	8.0 (114)	
	UL2	9.9 (50)	8.9 (48)	9.3 (49)	8.6 (48)	77.5 (172)	71.9 (161)	45.9 (115)	39 (102)	28.9 (411)	7.8 (111)	
18k	UL2	10 (50)	10 (50)	11.5 (53)	11.7 (53)	77.8 (172)	74.9 (166)	49.5 (121)	42.1 (108)	30.6 (435)	8.8 (125)	
	UE	8.7 (48)	9.3 (49)	9.8 (50)	8.8 (48)	75.2 (167)	73.3 (164)	47.2 (117)	40.1 (104)	27.8 (395)	9.3 (133)	
24k	UE	7.7 (46)	7.7 (46)	9.5 (49)	7.3 (45)	80.3 (177)	75.6 (168)	50.1 (122)	40.5 (105)	30.1 (428)	9.0 (128)	
	UE1+	8.5 (47)	7.7 (46)	7.8 (46)	8.3 (47)	77.9 (172)	72 (162)	49.4 (121)	41.0 (106)	31 (440)	7.8 (111)	

- ※ Cycle Judgment Tolerance

Indoor HEX Temp. : 10(50) ± 5(9) °C (°F)

Outdoor HEX In : 74(165) ± 15(27) °C (°F)

Outdoor HEX Mid. : 48(118) ± 10(18) °C (°F)

Outdoor HEX Out : 40(104) ± 10(18) °C (°F)

Suction : More than 2(35) °C (°F)

Inv Td : 78(172) ± 15(27) °C (°F)

Pressure Low : 8.5(120) ± 3(43) kg/cm² (psi)

B4-1-b Cooling Overload Temperature : Indoor 32 °C (90 °F) / Outdoor 48 °C (118 °F)
Remote Control Setting : 18°C (34 °F) / High

Capacity (B.T.U)	Tool	Pipe Length (m/ft)	Indoor °C (°F)			Outdoor °C (°F)					kgf/cm ² (psi)	
			HEX In	HEX Mid.	HEX Out	Suction	INV Td	HEX In	HEX Mid.	HEX Out	Pressure High	Pressure Low
			9k	UA3	7.5(24.6)	18.5 (65)	18.9 (66)	17.9 (64)	16.8 (62)	79.7 (175)	76.7 (170)	58.9 (138)
12k	UA3	20(65.6)	19.7 (66)	19.1 (66)	19.0 (66)	17.3 (63)	76.3 (169)	70.7 (159)	57.1 (135)	55.4 (132)	39.5 (561)	12.2 (173)
	UL2	7.5(24.6)	18.3 (65)	19 (66)	17.8 (64)	18.6 (65)	79.3 (175)	71.9 (161)	55.1 (131)	53.4 (128)	37.3 (530)	11.9 (169)
18k	UL2	7.5(24.6)	16.3 (61)	17.3 (63)	17.9 (64)	23.9 (75)	87.5 (190)	82.2 (180)	55.5 (132)	51.5 (125)	35.6 (506)	11.2 (159)
	UE	20(65.6)	18.2 (65)	18.4 (65)	19.3 (67)	20.9 (70)	82.4 (180)	77.2 (171)	54.8 (131)	52.4 (126)	35.7 (507)	11.8 (168)
24k	UE	7.5(24.6)	18 (64)	18.4 (65)	19.5 (67)	22.8 (73)	87.9 (190)	81.2 (178)	57.4 (135)	55.3 (132)	36.1 (513)	11.9 (169)
	UE1+	20(65.6)	18.6 (65)	18.4 (65)	19.8 (68)	16.8 (62)	84.4 (184)	76.1 (169)	55.4 (132)	52.1 (126)	38.4 (545)	12.3 (175)
18k	UE	7.5(24.6)	16 (61)	18.2 (65)	16.7 (62)	15.9 (61)	84.7 (184)	78.9 (174)	57.5 (136)	54.5 (130)	37.7 (535)	11.2 (159)
	UE1+	30(98.4)	17.9 (64)	18.3 (65)	18.3 (65)	15.3 (60)	82 (180)	77.1 (171)	56.6 (134)	53.4 (128)	32.2 (457)	13.9 (197)
24k	UE	7.5(24.6)	17.6 (64)	19.8 (68)	17.8 (64)	19.8 (68)	84.4 (184)	81.2 (178)	57.3 (135)	54.5 (130)	37.3 (530)	12.0 (170)
	UE1+	30(98.4)	17.6 (64)	18.1 (65)	18.5 (65)	16.0 (61)	82.6 (181)	75.9 (169)	56.8 (134)	52 (126)	37.9 (538)	11.9 (169)
18k	UE	7.5(24.6)	16.1 (61)	16.5 (62)	17.1 (63)	17.5 (64)	81.8 (179)	77.4 (171)	57.4 (135)	53.6 (128)	36.5 (518)	10.8 (153)
	UE1+	30(98.4)	16.7 (62)	17.4 (63)	17.1 (63)	18.9 (66)	81.5 (179)	72.5 (163)	58.1 (137)	50.6 (123)	36.9 (524)	11.2 (159)

- ※ Cycle Judgment Tolerance

Indoor HEX Temp. : 18(64) ± 5(9) °C (°F)

Outdoor HEX In : 74(165) ± 15(27) °C (°F)

Outdoor HEX Mid. : 57(135) ± 10(18) °C (°F)

Outdoor HEX Out : 40(130) ± 10(18) °C (°F)

Suction : More than 12(54) °C (°F)

Inv Td : 78(172) ± 15(27) °C (°F)

Pressure Low : 12(171) ± 3(43) kg/cm² (psi)

4. Appendix B (LG SIMs)

B4-1-c Cooling Low Temperature : Indoor 21 °C (70 °F)/ Outdoor 21 °C (70 °F)
Remote Control Setting : 18°C (34 °F) / Low

Capacity (B.T.U)	Tool	Pipe Length (m/ft)	Indoor			Outdoor							
			°C (°F)			°C (°F)						kgf/cm ² (psi)	
			HEX In	HEX Mid.	HEX Out	Suction	INV Td	HEX In	HEX Mid.	HEX Out	Pressure High	Pressure Low	
9k	UA3	7.5(24.6)	3.5 (38)	3.2 (38)	2.7 (37)	1.4 (34)	40 (104)	35.3 (96)	29.3 (85)	27.6 (82)	18.5 (263)	7.4 (105)	
		20(65.6)	3.1 (38)	3.3 (38)	2.5 (36)	-0.8 (31)	37.2 (99)	31.5 (89)	30.6 (87)	26.7 (80)	20.5 (286)	7.1 (101)	
12k	UA3	7.5(24.6)	4.6 (40)	4.4 (40)	5.6 (42)	5.6 (42)	44 (111)	38.4 (101)	28.2 (83)	23.5 (74)	18.1 (257)	7.7 (109)	
		20(65.6)	5 (41)	5.3 (41)	5.9 (43)	2.9 (37)	42.9 (109)	37.7 (100)	30.1 (86)	24.3 (76)	18.3 (260)	7.7 (110)	
	UL2	7.5(24.6)	4.1 (39)	4.3 (40)	5.5 (42)	5.9 (43)	42.7 (109)	36.9 (98)	27.4 (81)	23.4 (74)	17.6 (251)	7.6 (108)	
		20(65.6)	4.9 (41)	5.3 (42)	6 (43)	3.2 (38)	43.2 (110)	38.1 (101)	28.1 (83)	24.6 (76)	17.7 (252)	7.7 (110)	
18k	UL2	7.5(24.6)	6.3 (43)	5.8 (42)	6.8 (44)	6.5 (44)	47.4 (117)	40.2 (104)	30 (86)	27.9 (82)	19.5 (276)	8.0 (114)	
		20(65.6)	5.7 (42)	7.1 (45)	7.1 (45)	4.3 (40)	44.9 (113)	42.5 (109)	30.7 (87)	25.1 (77)	20.9 (297)	7.6 (108)	
24k	UE	7.5(24.6)	4.9 (41)	4.7 (40)	6.4 (43)	5.7 (42)	48.3 (119)	42 (108)	31.6 (89)	25.5 (78)	19.9 (283)	7.7 (110)	
		30(98.4)	4.6 (40)	4.7 (40)	4.9 (41)	3.0 (37)	44.7 (113)	38.5 (101)	29.6 (85)	23.1 (74)	20.6 (292)	7.7 (110)	
	UE1+	7.5(24.6)	6.3 (43)	6.7 (44)	9.2 (49)	11.1 (52)	47.1 (117)	40.7 (105)	27.9 (82)	22.4 (72)	17.6 (250)	8.4 (119)	
		30(98.4)	5.7 (42)	6.1 (43)	7.6 (46)	11.1 (52)	48.8 (120)	38.9 (102)	28.3 (83)	22.5 (73)	17.7 (252)	8.1 (114)	

※ Cycle Judgment Tolerance

Indoor HEX Temp. : More then 0(32) °C (°F)
Outdoor HEX In : 38(100) ± 15(27) °C (°F)
Outdoor HEX Mid. : 32(90) ± 10(18) °C (°F)
Outdoor HEX Out : 32(90) ± 10(18) °C (°F)

Suction : 6(43) ± 9(16) °C (°F)
Inv Td : 44(111) ± 15(27) °C (°F)
Pressure Low : 8(114) ± 3(43) kg/cm² (psi)

■ B4-2. Heating Mode

Determine the normal temperature range referring to the Reference Cycle data for each indoor/outdoor temperature condition

※ Under the heating operation mode, Inv.Td should always higher than the temperature of the indoor pipe. IF Inv.Td temperature is same or lower than the indoor pipe temperature, the confirmation for the sensor insertion faulty/characteristics faulty is required.

B4-2-a Standard Heating Temperature : Indoor 20 °C (68 °F)/ Outdoor 7 °C (45 °F)
Remote Control Setting : 30°C (86 °F) / High

Capacity (B.T.U)	Tool	Pipe Length (m/ft)	Indoor			Outdoor							
			°C (°F)			°C (°F)						kgf/cm ² (psi)	
			HEX In	HEX Mid.	HEX Out	Suction	INV Td	HEX In	HEX Mid.	HEX Out	Pressure High	Pressure Low	
9k	UA3	7.5(24.6)	59.7 (139)	44.4 (112)	41.5 (107)	1.4 (34)	70.2 (158)	1.6 (35)	0.7 (33)	2.1 (36)	28.4 (404)	6.7 (95)	
12k	UA3		57.6 (136)	46.6 (116)	43.3 (110)	-0.2 (32)	72.5 (162)	1.4 (35)	1 (34)	0.9 (34)	31.2 (444)	6.8 (96)	
	UL2		62.1 (144)	48.5 (119)	40.5 (105)	0.5 (33)	73 (163)	2.2 (36)	1.3 (34)	1.8 (35)	30.7 (436)	6.9 (98)	
18k	UL2		63.9 (147)	44.4 (112)	39.6 (103)	0.9 (34)	74.4 (166)	1.2 (34)	0.7 (33)	1.5 (35)	28.4 (403)	6.7 (94)	
24k	UE		65.1 (149)	48.9 (120)	43.8 (111)	-1.3 (30)	74 (165)	1 (34)	0.9 (34)	1.5 (35)	29.7 (422)	7.6 (108)	
	UE1+		68.8 (156)	51.0 (124)	43.7 (111)	-0.8 (31)	73.9 (165)	3.3 (38)	1.4 (35)	1.4 (34)	33.1 (470)	6.5 (93)	

※ Cycle Judgment Tolerance

Outdoor HEX Mid. : More then -1 (30) °C (°F)
Indoor HEX In : 63(145) ± 15(27) °C (°F)
Indoor HEX Mid. : 47(117) ± 10(18) °C (°F)
Indoor HEX Out : 42(108) ± 10(18) °C (°F)

Suction : 0(32) ± 3(5) °C (°F)
Inv Td : 73(163) ± 15(27) °C (°F)
Pressure Low : 7(100) ± 3(43) kg/cm² (psi)

B4-2-b Heating Overload Temperature : Indoor 27 °C (81 °F)/ Outdoor 24 °C (75 °F)
Remote Control Setting : 30°C (86 °F) / Low

Capacity (B.T.U)	Tool	Pipe Length (m/ft)	Indoor			Outdoor							
			°C (°F)			°C (°F)						kgf/cm ² (psi)	
			HEX In	HEX Mid.	HEX Out	Suction	INV Td	HEX In	HEX Mid.	HEX Out	Pressure High	Pressure Low	
9k	UA3	7.5(24.6)	66 (151)	49.3 (121)	48.1 (119)	20.8 (70)	75.2 (167)	15.6 (60)	16.4 (62)	19.5 (67)	31.8 (451)	11.5 (164)	
		20(65.6)	64.3 (148)	48.2 (119)	46.9 (116)	21.8 (71)	77.0 (171)	14.2 (58)	14.6 (58)	19.3 (67)	30.7 (435)	11.0 (157)	
12k	UL2	7.5(24.6)	63.5 (146)	51.1 (124)	44.4 (112)	14.2 (58)	72.9 (163)	16.8 (56)	13.3 (56)	14.3 (58)	32.2 (457)	10.6 (151)	
		20(65.6)	63.2 (146)	50.3 (122)	44.3 (112)	14.3 (58)	73.0 (163)	12.8 (55)	12.8 (55)	14.3 (58)	32 (454)	10.8 (153)	
18k	UL2	7.5(24.6)	65.6 (150)	48.8 (120)	44.6 (112)	15.1 (59)	75.7 (168)	11.3 (52)	11.2 (52)	13.4 (56)	31.2 (443)	9.8 (139)	
		20(65.6)	64.5 (148)	48.7 (120)	45.5 (114)	17.2 (63)	80.1 (176)	10.8 (52)	11.2 (52)	14.8 (59)	30.9 (438)	9.7 (137)	
24k	UE	7.5(24.6)	64.5 (148)	50.8 (123)	48.5 (119)	13.0 (55)	70.9 (160)	13.3 (56)	13.4 (56)	14.2 (58)	32.1 (456)	10.8 (154)	
		30(98.4)	61.5 (143)	49.5 (121)	47.7 (118)	15.1 (59)	72.4 (162)	12.2 (54)	12.4 (54)	14.4 (58)	31.4 (446)	10.5 (150)	

※ Cycle Judgment Tolerance

Outdoor HEX Mid. : 13(60) ± 8(14) °C (°F)
Indoor Pipe In : 63(145) ± 15(27) °C (°F)
Indoor Pipe Mid. : 47(117) ± 10(18) °C (°F)
Indoor Pipe Out : 42(108) ± 10(18) °C (°F)

Suction : 17(63) ± 7(13) °C (°F)
Inv Td : 73(163) ± 15(27) °C (°F)
Pressure Low : 11(156) ± 3(43) kg/cm² (psi)

4. Appendix B (LG SIMs)

B4-2-c Heating Low Temperature : Indoor 16 °C (61 °F)/ Outdoor -10 °C (14 °F)
Remote Control Setting : 30°C (86 °F) / Low

Capacity (B.T.U)	Tool	Pipe Length (m/ft)	Indoor			Outdoor							
			°C (°F)			°C (°F)						kgf/cm ² (psi)	
			HEX In	HEX Mid.	HEX Out	Suction	INV Td	HEX In	HEX Mid.	HEX Out	Pressure High	Pressure Low	
9k	UA3	7.5(24.6)	45.5 (114)	35.9 (97)	35.7 (96)	-16.2 (3)	57 (135)	-14.2 (7)	-13.6 (7)	-12.3 (10)	23.2 (330)	3.6 (51)	
		20(65.6)	40.4 (105)	35.9 (97)	35.6 (96)	-15.6 (4)	55.2 (131)	-14.5 (6)	-13 (9)	-12.6 (9)	23 (326)	3.6 (52)	
12k	UL2	7.5(24.6)	59.2 (139)	39.1 (102)	32.6 (91)	-16.2 (3)	74.6 (166)	-16.1 (3)	-16 (3)	-15.3 (5)	25.1 (356)	3.4 (48)	
		20(65.6)	55.6 (132)	40.5 (105)	29.3 (85)	-16.2 (3)	73.2 (164)	-15.9 (3)	-16.5 (2)	-15.5 (4)	25.9 (367)	3.5 (50)	
18k	UL2	7.5(24.6)	46.5 (116)	34.4 (94)	31.6 (89)	-19 (-2)	67.8 (154)	-17.6 (0)	-16.7 (2)	-16.1 (3)	22.5 (320)	2.9 (41)	
		20(65.6)	42.4 (108)	34.2 (93)	31.2 (88)	-19.1 (-2)	59.5 (139)	-16.9 (2)	-16.6 (2)	-15.9 (3)	22.1 (314)	2.9 (41)	
24k	UE	7.5(24.6)	47.5 (117)	37.8 (100)	32.9 (91)	-19.5 (-3)	58.9 (138)	-18.4 (-1)	-17.7 (0)	-17.6 (0)	24.3 (345)	3.0 (42)	
		30(98.4)	44 (111)	35.4 (96)	31.6 (89)	-19.1 (-2)	65.2 (149)	-17.6 (0)	-18.6 (-1)	-17.9 (0)	22.3 (317)	2.7 (38)	
	UE1+	7.5(24.6)	61.2 (142)	41.6 (107)	37.8 (100)	-21.3 (-6)	73.7 (165)	-18.0 (0)	-16.9 (2)	-15.9 (3)	27.8 (394)	2.9 (41)	
		30(98.4)	48.7 (120)	35.2 (95)	34.1 (93)	-20.4 (-5)	64.8 (149)	-18.2 (-1)	-16.8 (2)	-15.5 (4)	22.5 (320)	2.7 (38)	

※ Cycle Judgment Tolerance

Outdoor HEX Temp. : More then -30 (-22) °C (°F) Suction : more then -23(-9) ± 5(9) °C (°F)
 Indoor HEX In : 50(122) ± 15(27) °C (°F) Inv Td : 65(150) ± 15(27) °C (°F)
 Indoor HEX Mid. : 37(99) ± 10(18) °C (°F) Pressure Low : 2.5(36) ~ 8(114) kg/cm² (psi)
 Indoor HEX Out : 37(99) ± 10(18) °C (°F)

4. Appendix C (Electrical Part)

4. Appendix C (Electrical Part)

C1. PCBA

C1-1. PCBA Type Classification (1)

Check the type for PCBA P/NO(Part number) when performing product SVC, and refer to the measurement method for each type shown in the Appendix C.

TYPE 1	TYPE 2	TYPE 3	TYPE 4
Gen2 1.5kW	Gen2 2.0kW	Gen2 2.0kW Standby	Gen2 3.0kW
EBR803609 EBR801043 EBR780506 EBR771596 EBR741212 EBR730978 EBR770678 EBR785697 EBR718478 EBR727941 EBR786320 EBR752600	EBR741496 EBR783507 EBR765706	EBR807500 EBR746319 EBR770549 EBR790985	EBR746262 EBR779920 EBR772343 EBR805607 EBR765707 EBR770391 EBR791872 EBR793644
TYPE 5	TYPE 6	TYPE 7	TYPE 8
Gen2 4.0kW	Gen2 3.0kW I-PFC	Gen2 4.0kW I-PFC	Gen2 1.5kW 115V
EBR770974 EBR750746 EBR723479 EBR785343 EBR770392	EBR788632	EBR774517	EBR772723

If Part Number is not in the table, Please find similar PCBA shape to see the photos.

C1-1. PCBA Type Classification (2)

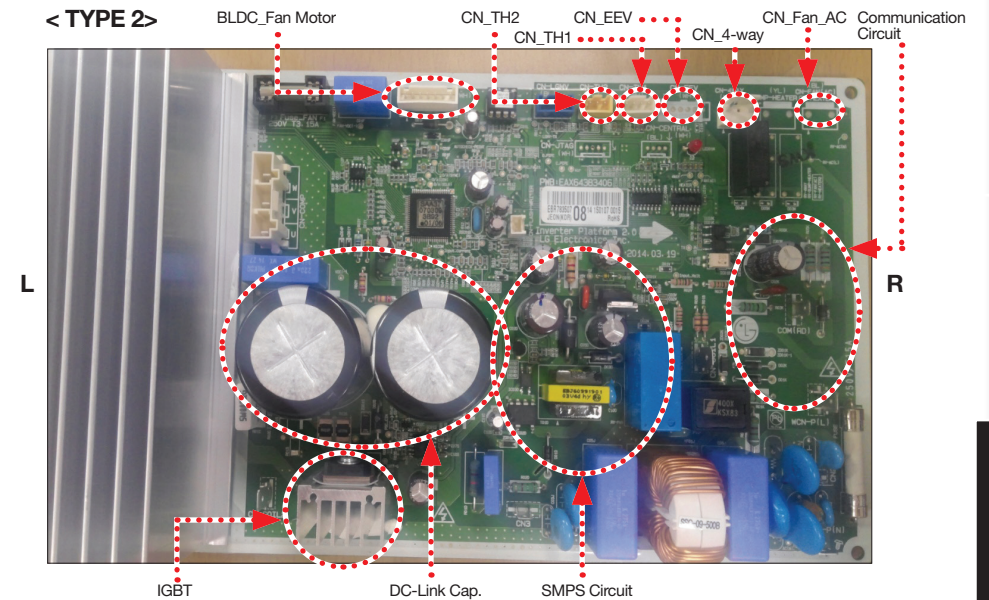
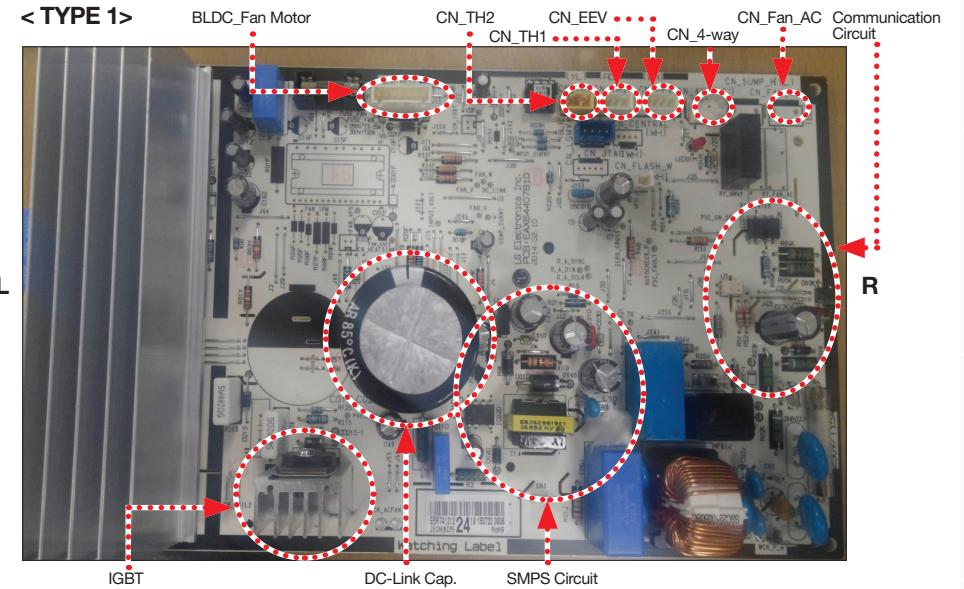

4. Appendix C (Electrical Part)

C1-1. PCBA Type Classification (3)

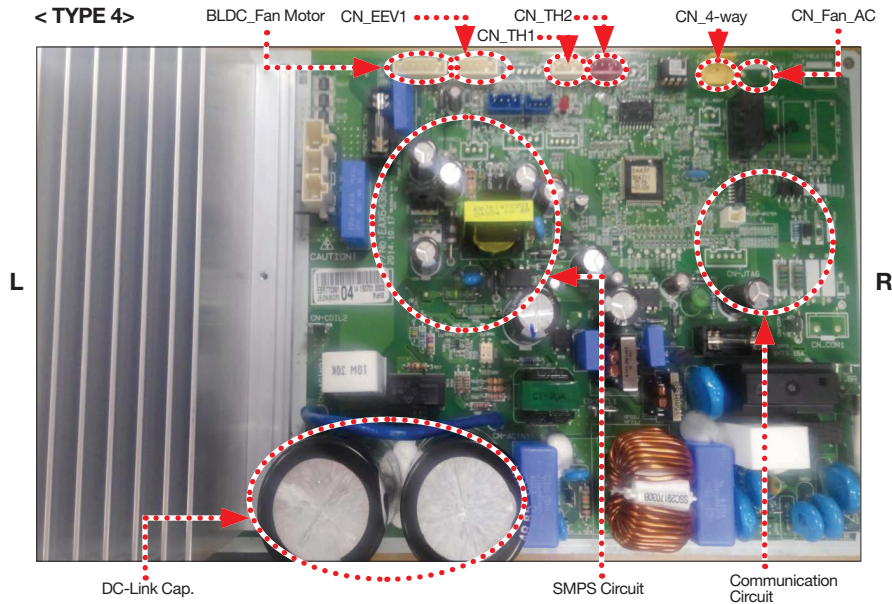
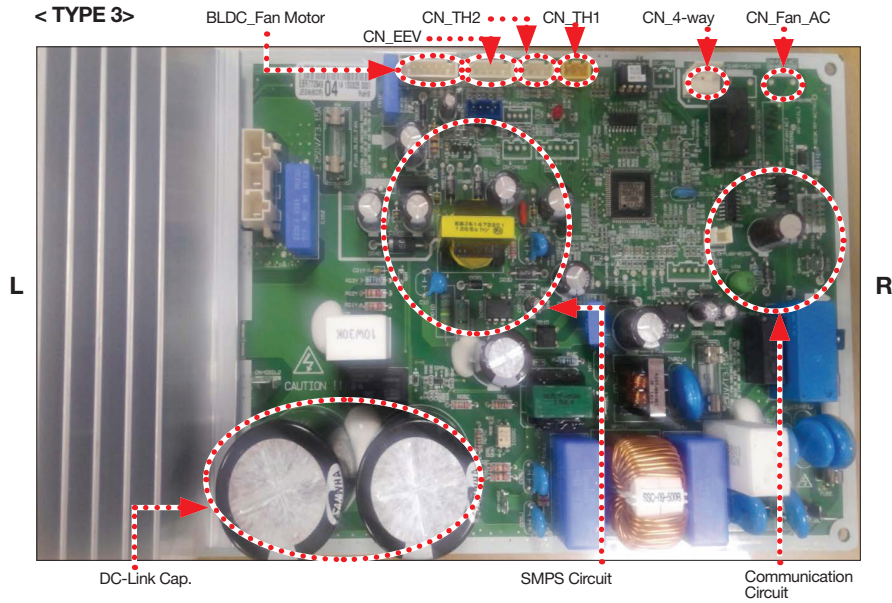

C1-1. PCBA Type Classification (4)

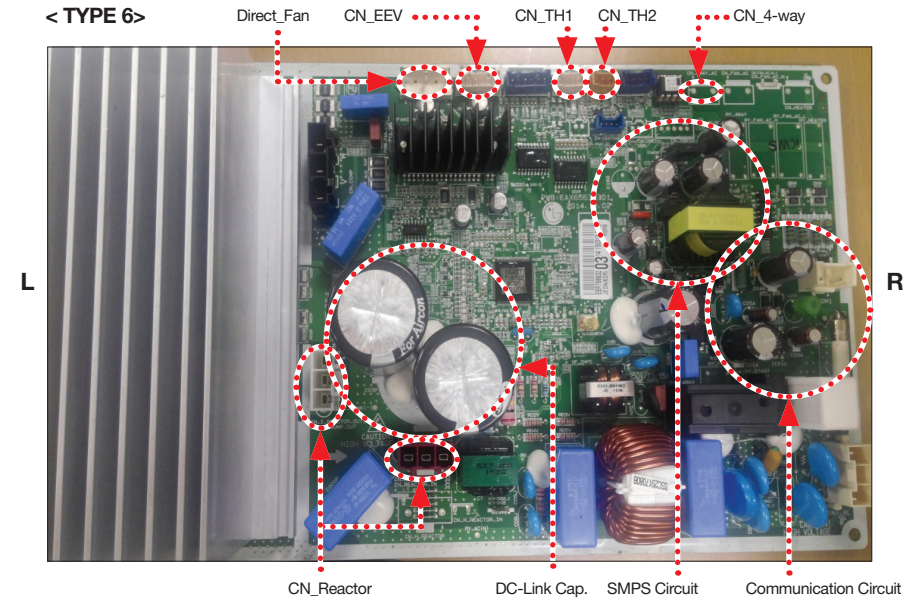
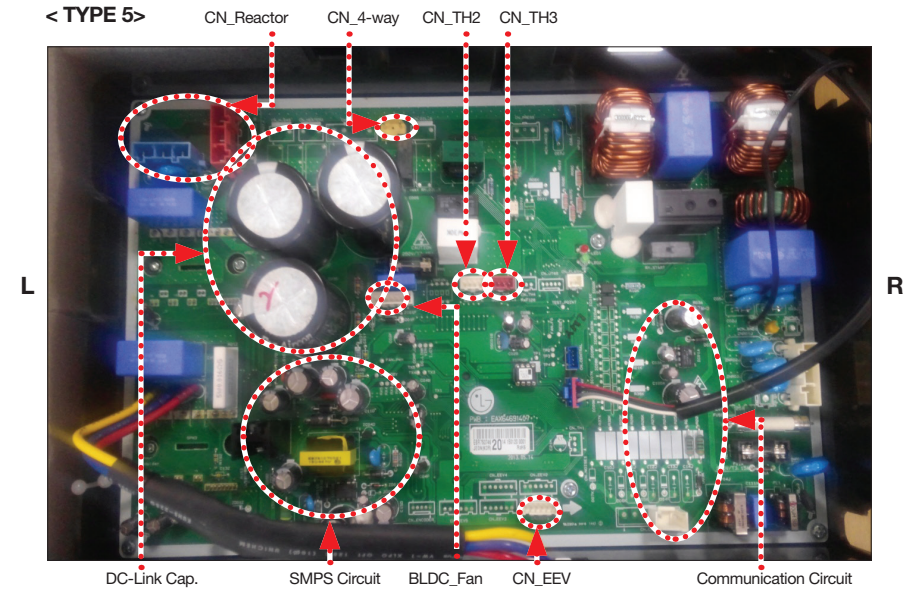

4. Appendix C (Electrical Part)

C1-1. PCBA Type Classification (5)

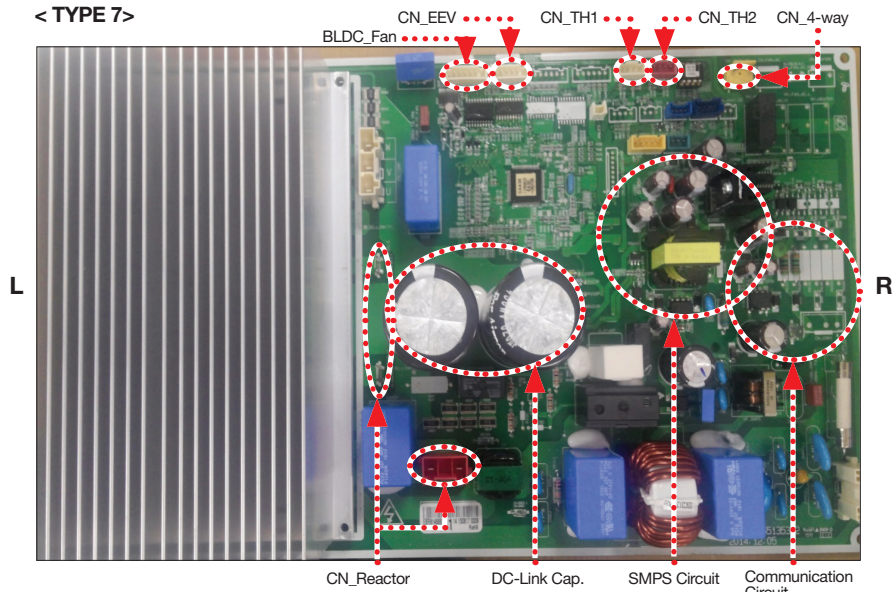

C1-2. Key measurement points for each type (1)

<TYPE 1>

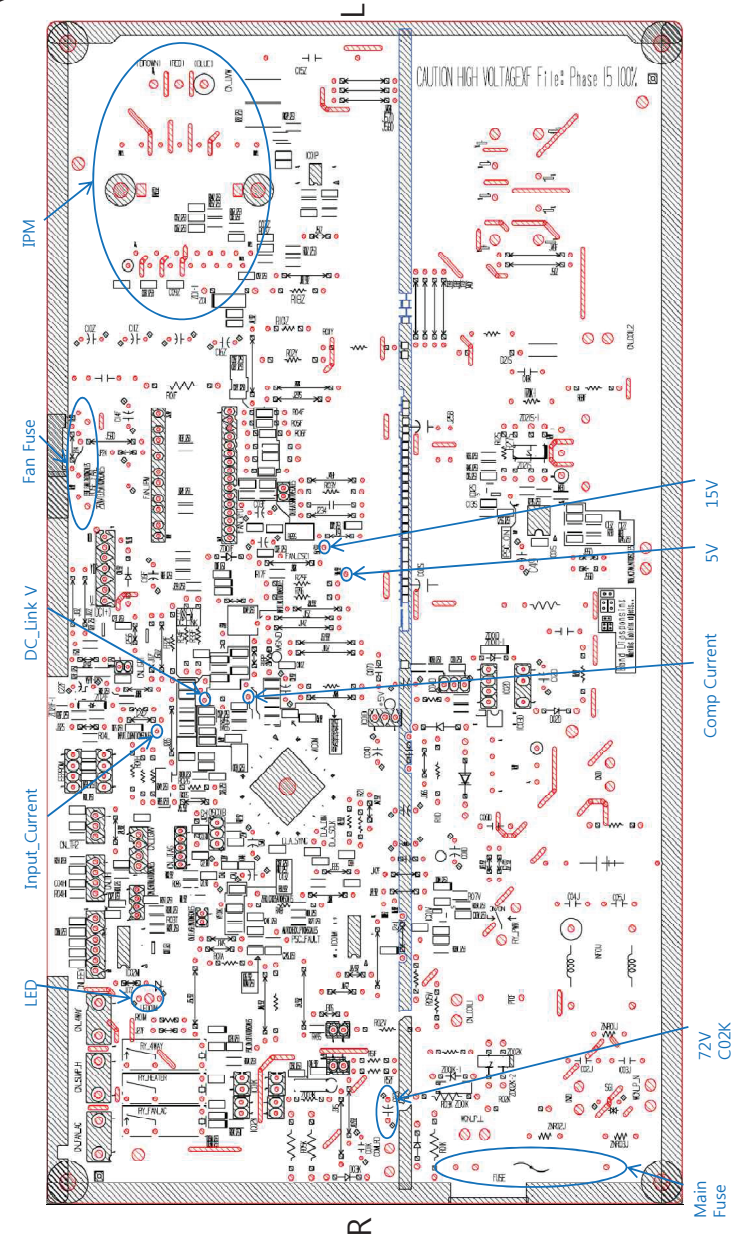

※ Measurement Point.
 ※ For detailed measuring point, refer to App. for each items.

4. Appendix C (Electrical Part)

C1-2. Key measurement points for each type (2) <TYPE 2>

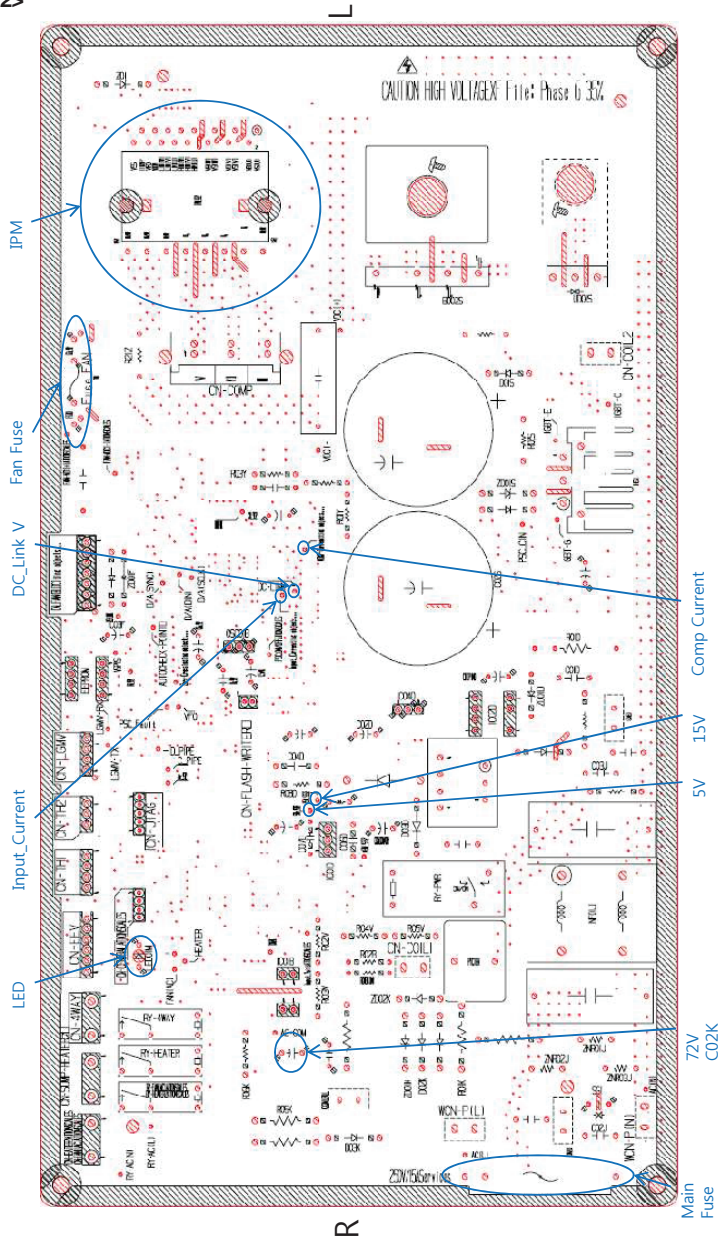

※ Measurement Point.

-> For detailed measuring point, refer to App. for each items.

C1-2. Key measurement points for each type (3) <TYPE 3>

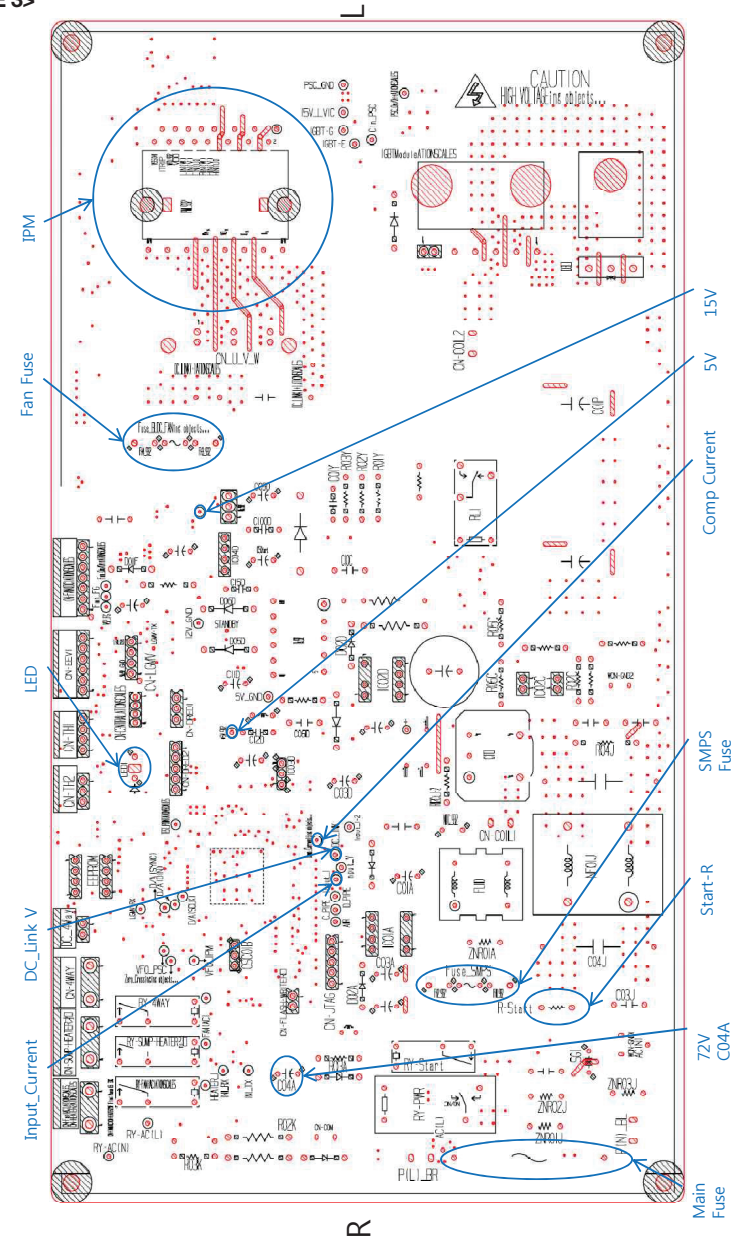

※ Measurement Point.

-> For detailed measuring point, refer to App. for each items.

4. Appendix C (Electrical Part)

C1-2. Key measurement points for each type (4) <TYPE 4>

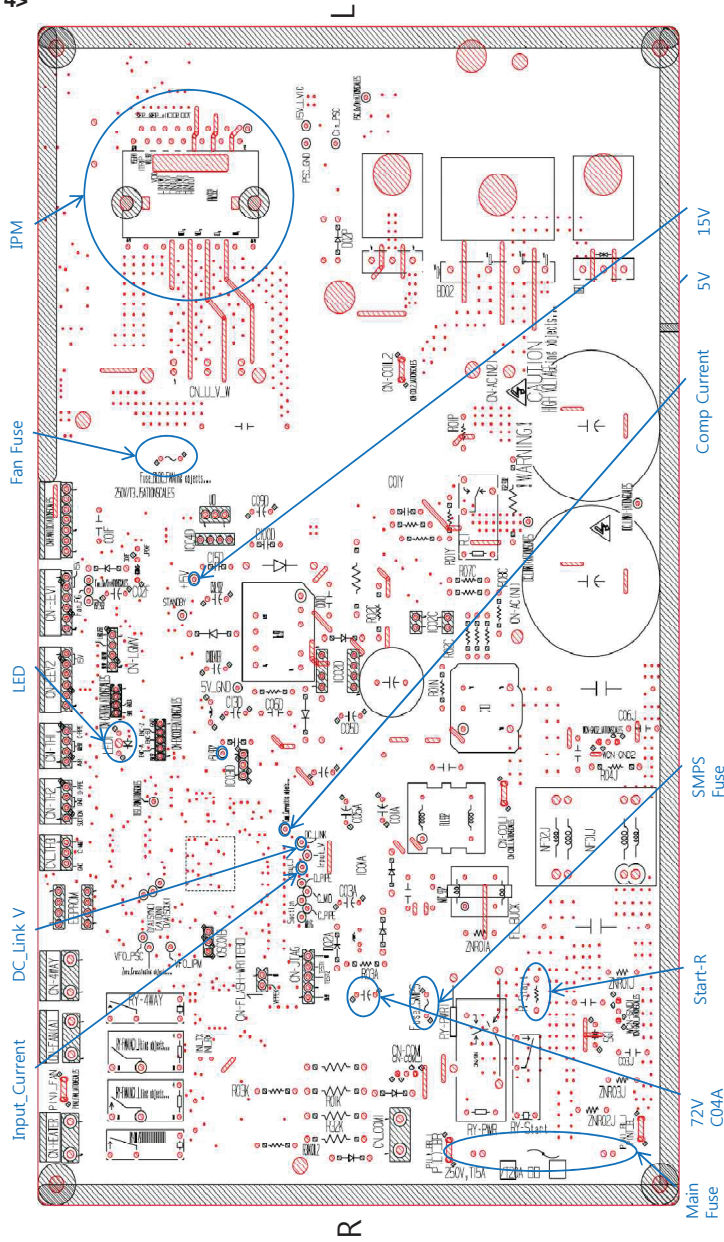

※ Measurement Point.
-> For detailed measuring point, refer to App. for each items.

C1-2. Key measurement points for each type (5) <TYPE 5>

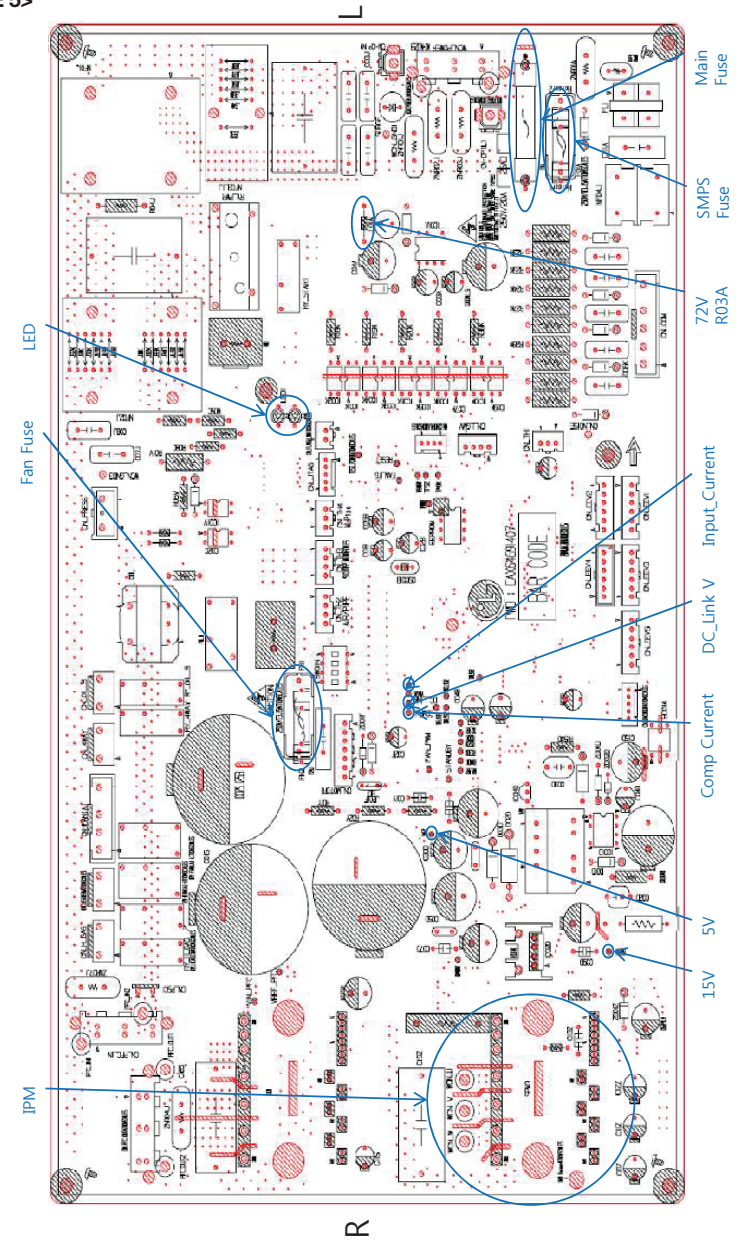

※ Measurement Point.
-> For detailed measuring point, refer to App. for each items.

4. Appendix C (Electrical Part)

C1-2. Key measurement points for each type (6)
<TYPE 6>

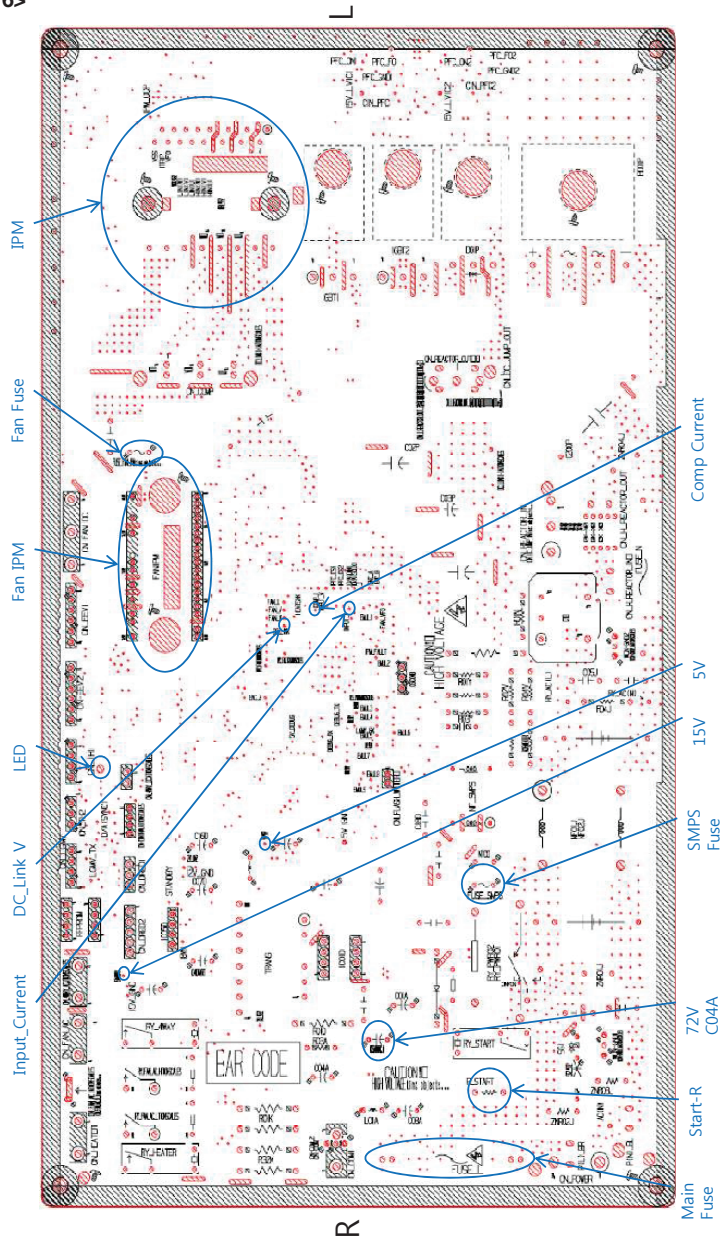

※ Measurement Point.
-> For detailed measuring point, refer to App. for each items.

C1-2. Key measurement points for each type (7)
<TYPE 7>

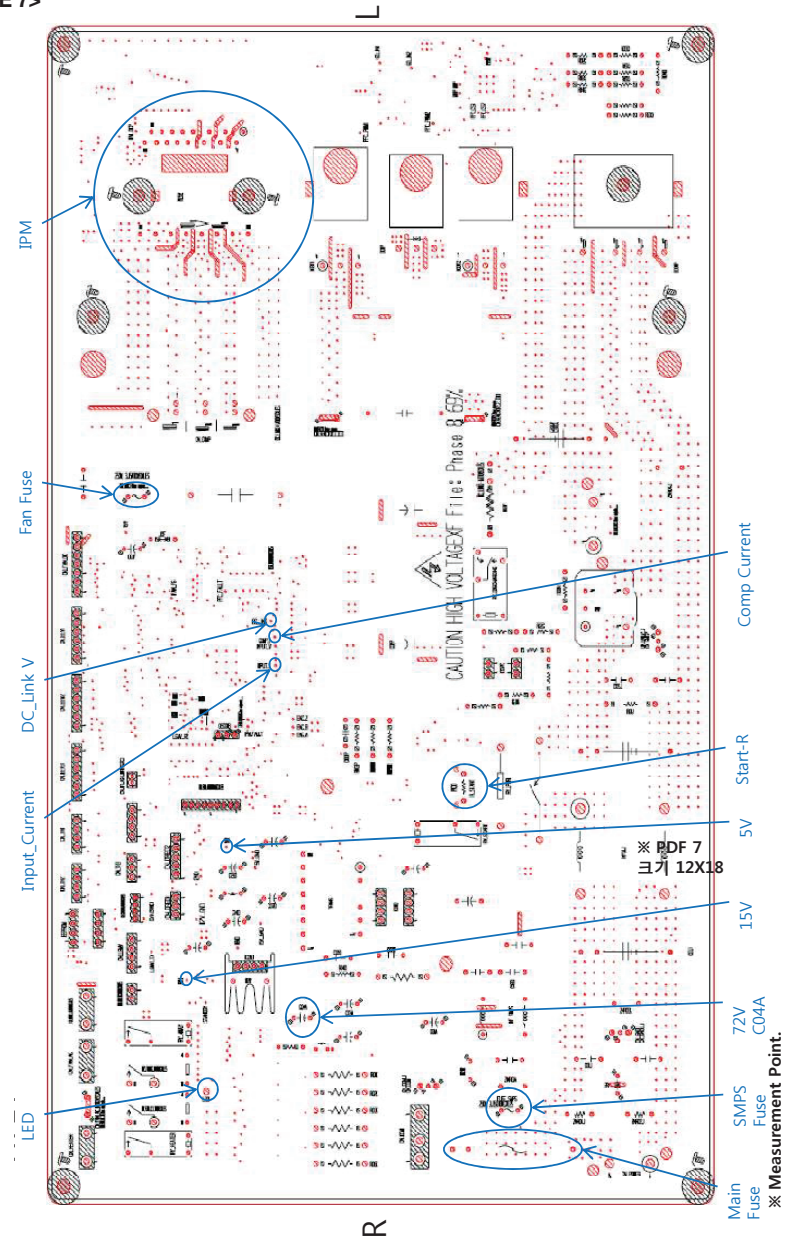

※ Measurement Point.
-> For detailed measuring point, refer to App. for each items.

4. Appendix C (Electrical Part)

C1-3. Main Fuse (1)

Outdoor Main Fuse-Type Common

<Top side>

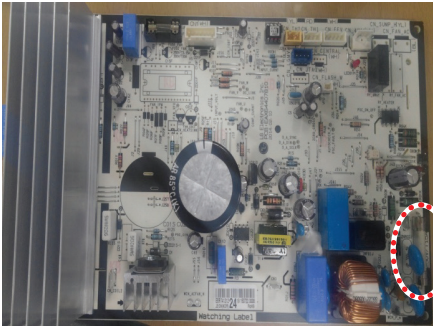

LED Off, CH05 occurs when main fuse is open
→ Replace PCBA

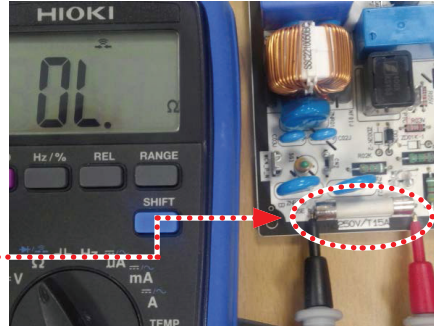

If there is no sound when measuring the ends of the fuse with the sound mode of the multi meter, judge it as 'Fuse burn-out open', if sound is heard, judge it as 'Normal short'

<Bottom Side>

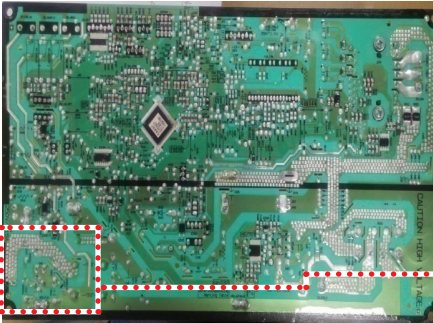

<Type5 Top Side>

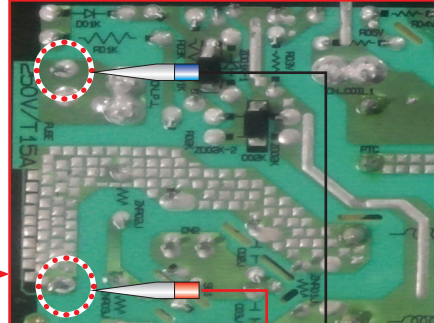
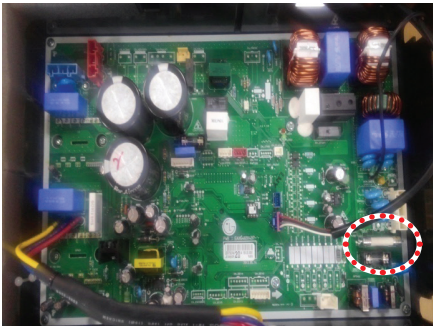

Enlargement of the actual product

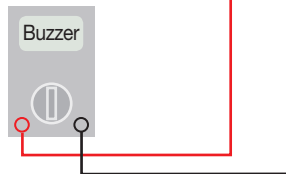

- ※ When measuring the bottom side, do it after scraping the coating gently.
- ※ For Type5, measure it at the Top side.

C1-3. Main Fuse (2)

Indoor Main Fuse



Indoor unit is not operated when main fuse is open (Display Off, No operation buzzer sound)
In case CH05, CH53 occurs with outdoor PCBA LED → Replace indoor PCBA.

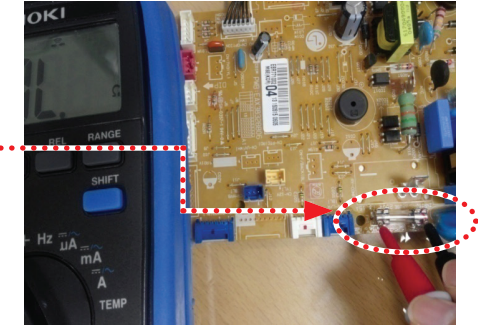

4. Appendix C (Electrical Part)

※ When measuring the bottom side, do it after scraping the coating gently.

C1-4. BLDC Fan Motor Fuse

BLDC Fan Motor Fuse-Type Common

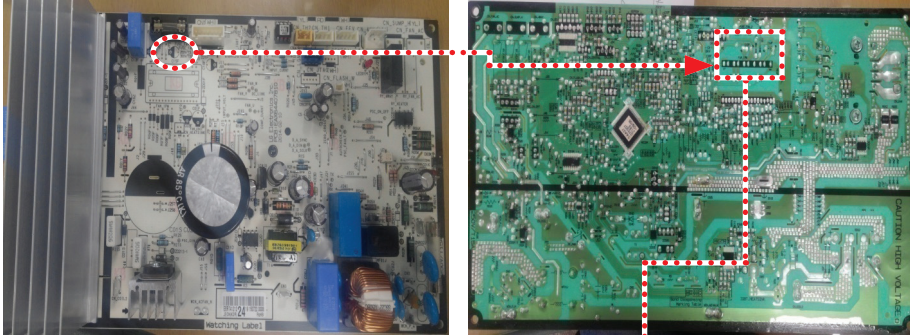

If there is no sound when measuring the ends of the fuse with the sound mode of the multi meter, judge it as 'Fuse burn-out open', if sound is heard, judge it as 'Normal short'

When Fan Fuse Open occurs, it is estimated that the Number 1 & 4 pin Short burn-out may occur, then CH67 occurs.

—Inspect the BLDC Motor—Replace the motor
—If Motor is normal, replace the Fuse and check whether there happens same phenomenon.

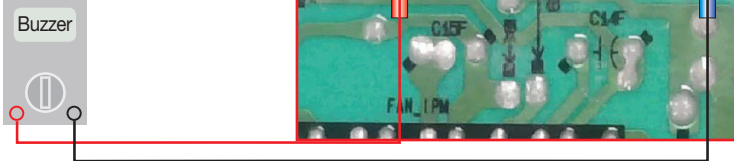

Enlargement of the actual product

<Type5 Top side>

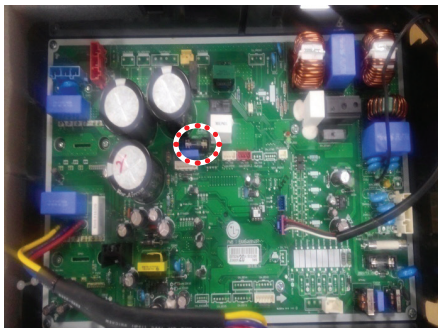

※ For Type5, measure it at the Top side.

<Type6, Type7 Top side>



※ For Type6 and Type7, Fuse is Box Type.

C1-5. SMPS Fuse

SMPS Fuse-Type3, Type4, Type5, Type6, Type7

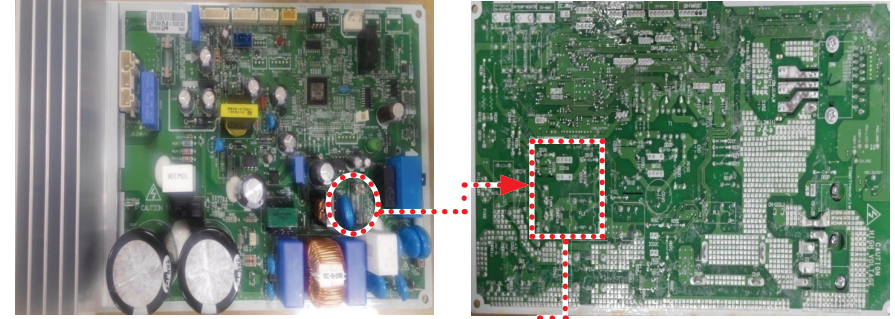

If there is no sound when measuring the ends of the fuse with the sound mode of the multi meter, judge it as 'Fuse burn-out open', if sound is heard, judge it as 'Normal short'

LED Off, CH05 occurs when SMPS fuse is open
— Check the exterior burn-out status of PCBA and if burnt out, replace PCBA.

※ If you want to replace the fuse only, check the short status of the ends of C01A and C01D. Replace Fuse only when it is open. If it is short at the corresponding side, fuse burn-out again.

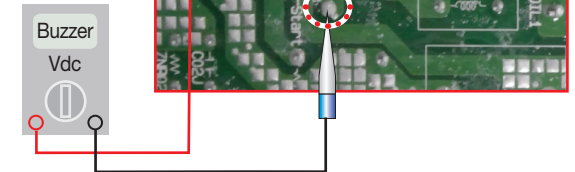

Enlargement of the actual product

<Type5 Top side>

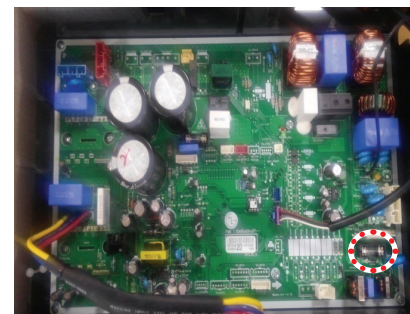

※ For Type5, measure it at the Top side.

<Type6, Type7 Top side>



※ For Type6 and Type7, Fuse is Box Type.

4. Appendix C (Electrical Part)



- ※ Be sure to pay attention as it is high pressure.
- Be sure to pay attention as it is high pressure.
- Wear insulated gloves and be careful skin does not contact PCBA

※ When measuring the bottom side, do it after scraping the coating gently.

C1-6. SMPS circuit check (1)

SMPS output circuit measurement method & Point-Type1

If PCBA is normal, be sure to perform voltage output at SMPS when applying power.
 Remove all the load connector and confirm output of SMPS 5V & 15V under the state of applying power only to PCBA.
 5V : 4.75 ~ 5.25 V
 15V : 14.25 ~ 15.75 V
 If above value does not come Out, replace PCBA

Enlargement of the actual product

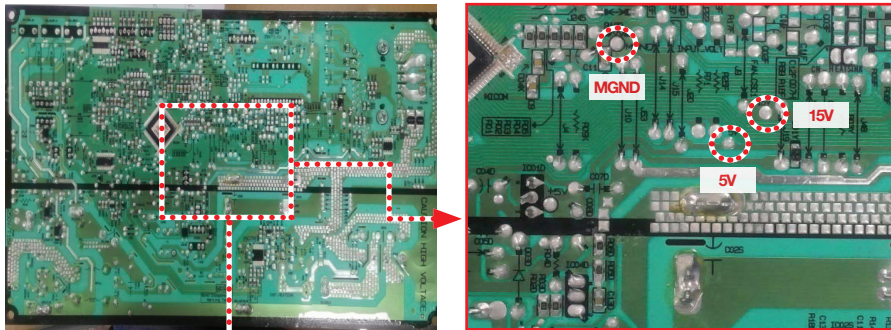

Drawing
Enlargement

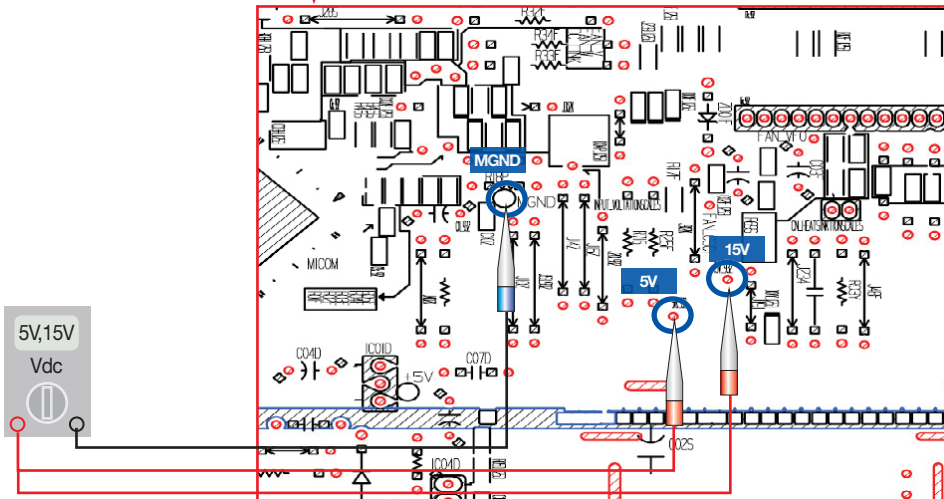

- ※ Be sure to pay attention as it is high pressure.
- Be sure to pay attention as it is high pressure.
- Wear insulated gloves and be careful skin does not contact PCBA

※ When measuring the bottom side, do it after scraping the coating gently.

C1-6. SMPS circuit check (2)

SMPS output circuit measurement method & Point-Type2

If PCBA is normal, be sure to perform voltage output at SMPS when applying power.
 Remove all the load connector and confirm output of SMPS 5V & 15V under the state of applying power only to PCBA.
 5V : 4.75 ~ 5.25 V
 15V : 14.25 ~ 15.75 V
 If above value does not come Out, replace PCBA.

Enlargement of the actual product

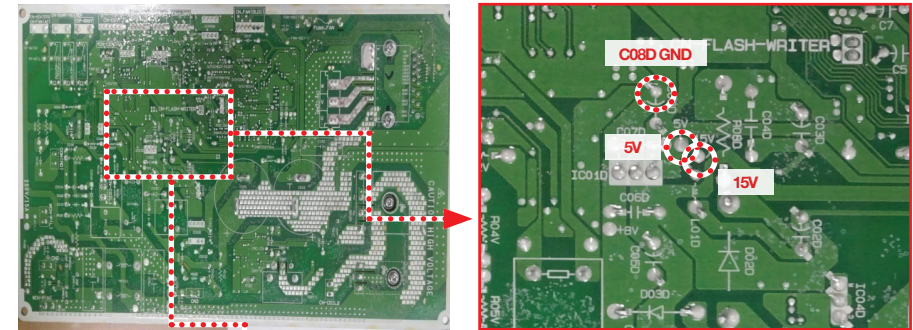

Drawing
Enlargement

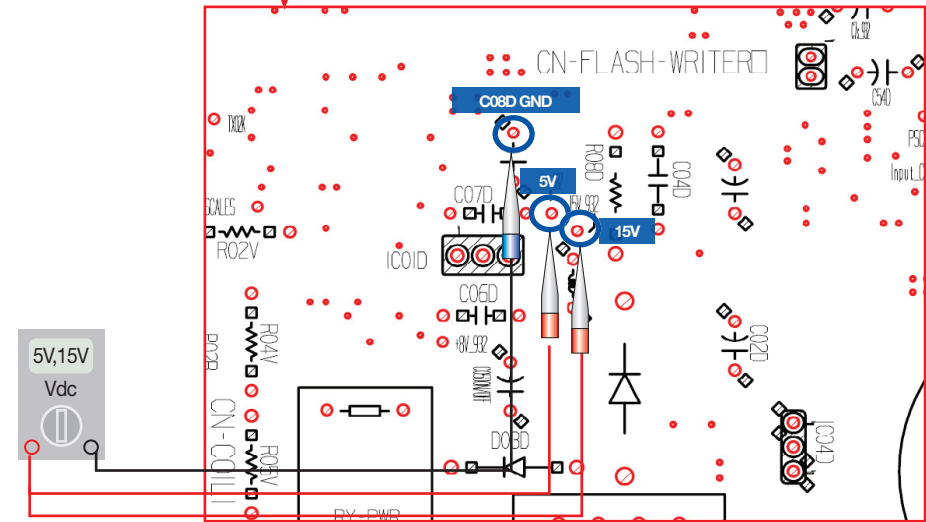

4. Appendix C (Electrical Part)



- ※ Be sure to pay attention as it is high pressure.
- Be sure to pay attention as it is high pressure.
- Wear insulated gloves and be careful skin does not contact PCBA

※ When measuring the bottom side, do it after scraping the coating gently.

C1-6. SMPS circuit check (3)

SMPS output circuit measurement method & Point-Type3

If PCBA is normal, be sure to perform voltage output at SMPS when applying power. Remove all the load connector and confirm output of SMPS 5V & 15V under the state of applying power only to PCBA.

5V : 4.75 ~ 5.25 V
15V : 14.25 ~ 15.75 V

If above value does not come Out, replace PCBA.

Enlargement of the actual product

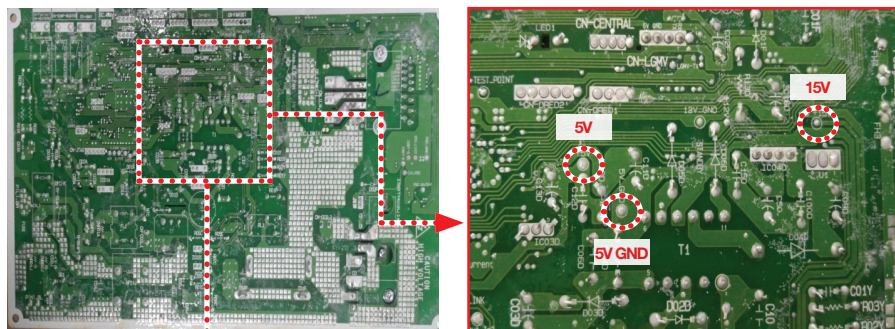

Drawing
Enlargement

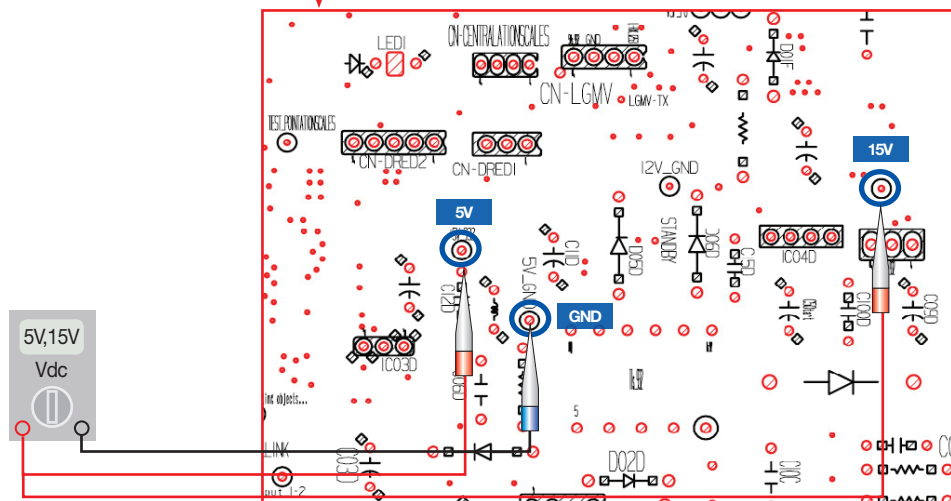

- ※ Be sure to pay attention as it is high pressure.
- Be sure to pay attention as it is high pressure.
- Wear insulated gloves and be careful skin does not contact PCBA

※ When measuring the bottom side, do it after scraping the coating gently.

C1-6. SMPS circuit check (4)

SMPS output circuit measurement method & Point-Type4

If PCBA is normal, be sure to perform voltage output at SMPS when applying power. Remove all the load connector and confirm output of SMPS 5V & 15V under the state of applying power only to PCBA.

5V : 4.75 ~ 5.25 V
15V : 14.25 ~ 15.75 V

If above value does not come Out, replace PCBA.

Enlargement of the actual product

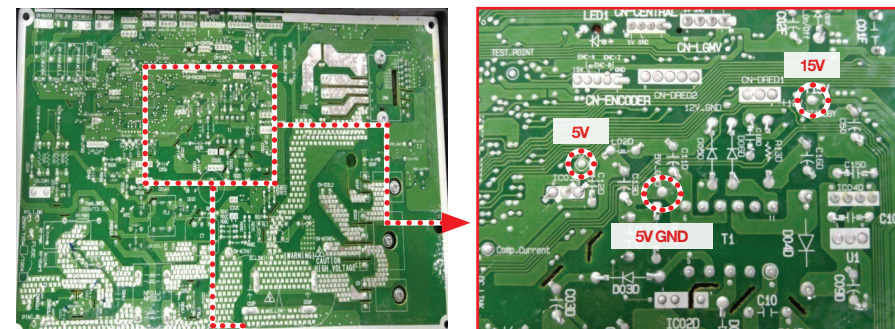

Drawing
Enlargement

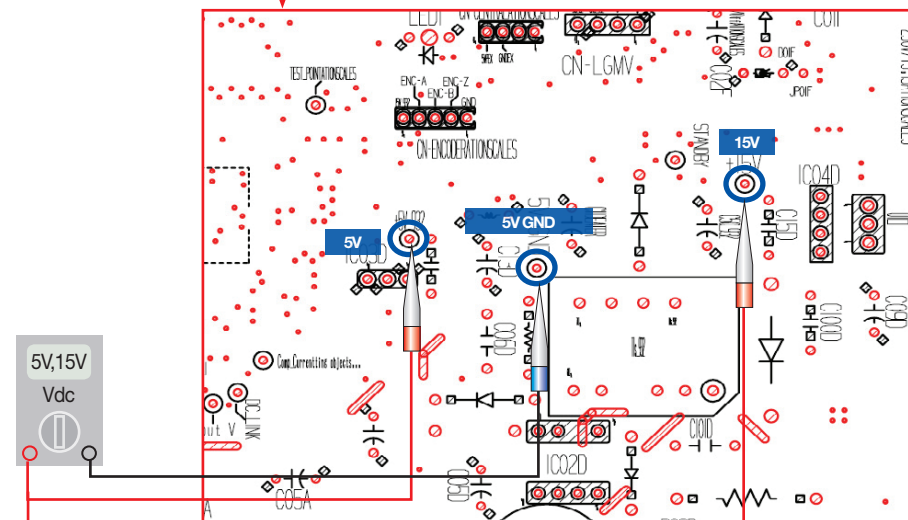

4. Appendix C (Electrical Part)



- ※ Be sure to pay attention as it is high pressure.
- Be sure to pay attention as it is high pressure.
- Wear insulated gloves and be careful skin does not contact PCBA

※ When measuring the bottom side, do it after scraping the coating gently.

C1-6. SMPS circuit check (5)

SMPS output circuit measurement method & Point-Type5

If PCBA is normal, be sure to perform voltage output at SMPS when applying power.
 Remove all the load connector and confirm output of SMPS 5V & 15V under the state of applying power only to PCBA.
 5V : 4.75 ~ 5.25 V
 15V : 14.25 ~ 15.75 V
 If above value does not come Out, replace PCBA.

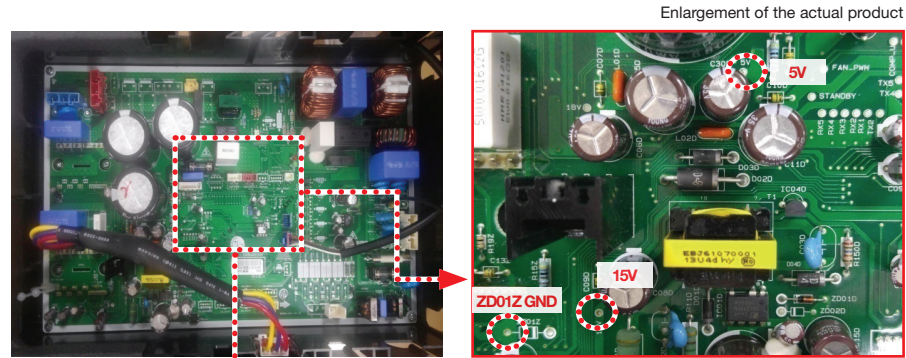

Enlargement of the actual product

Drawing Enlargement

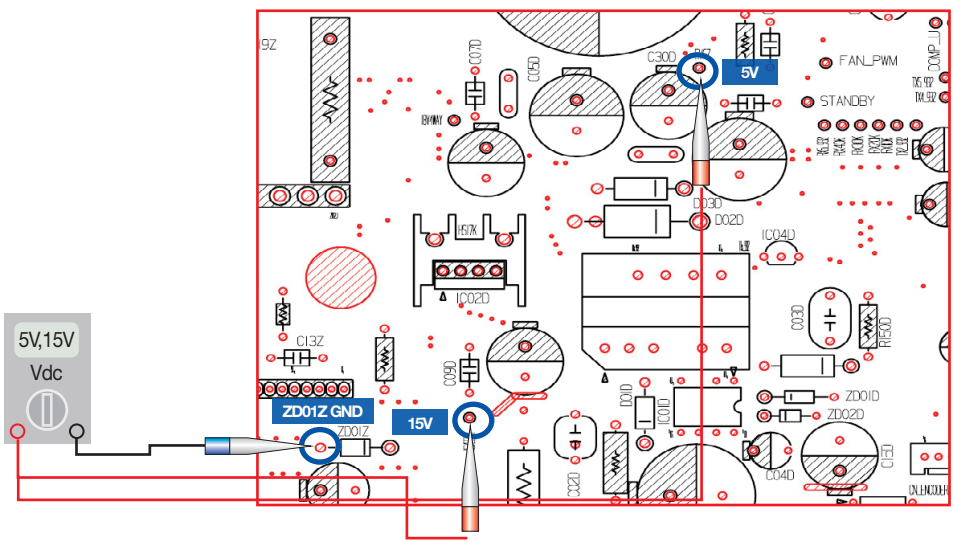

- ※ Be sure to pay attention as it is high pressure.
- Be sure to pay attention as it is high pressure.
- Wear insulated gloves and be careful skin does not contact PCBA

※ When measuring the bottom side, do it after scraping the coating gently.

C1-6. SMPS circuit check (6)

SMPS output circuit measurement method & Point-Type6

If PCBA is normal, be sure to perform voltage output at SMPS when applying power.
 Remove all the load connector and confirm output of SMPS 5V & 15V under the state of applying power only to PCBA.
 5V : 4.75 ~ 5.25 V
 15V : 14.25 ~ 15.75 V
 If above value does not come Out, replace PCBA.

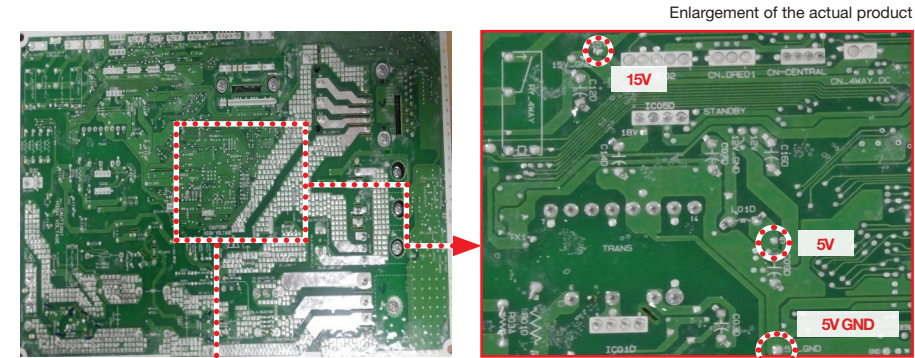

Enlargement of the actual product

Drawing Enlargement

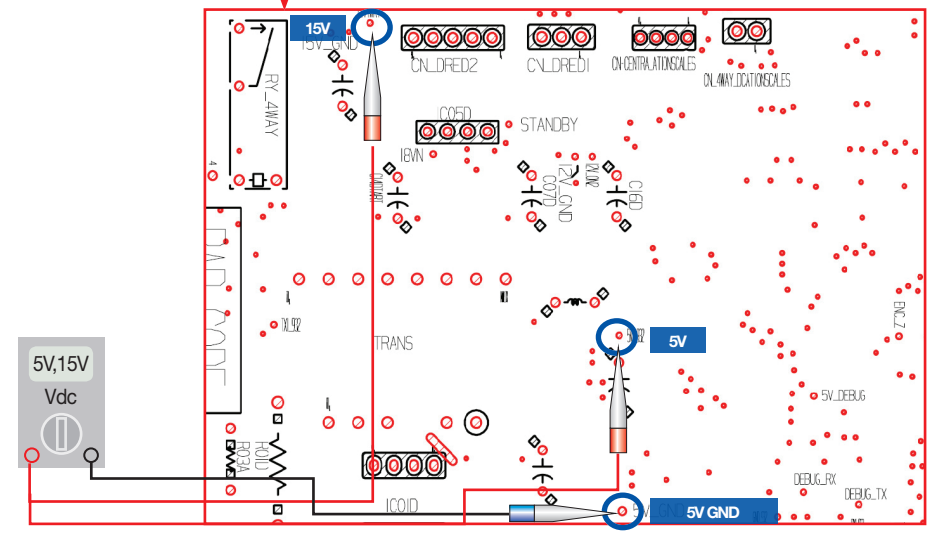

4. Appendix C (Electrical Part)



- ※ Be sure to pay attention as it is high pressure.
- Be sure to pay attention as it is high pressure.
- Wear insulated gloves and be careful skin does not contact PCBA

※ When measuring the bottom side, do it after scraping the coating gently.

C1-6. SMPS circuit check (7)

SMPS output circuit measurement method & Point-Type7

If PCBA is normal, be sure to perform voltage output at SMPS when applying power.
Remove all the load connector and confirm output of SMPS 5V & 15V under the state of applying power only to PCBA.

5V : 4.75 ~ 5.25 V
15V : 14.25 ~ 15.75 V

If above value does not come Out, replace PCBA.

Enlargement of the actual product

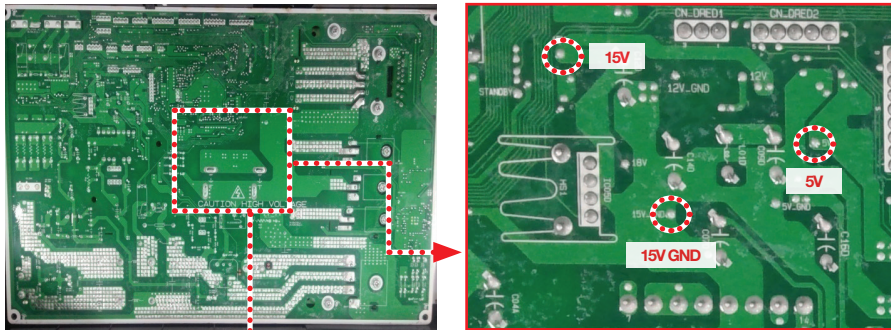

Drawing
Enlargement

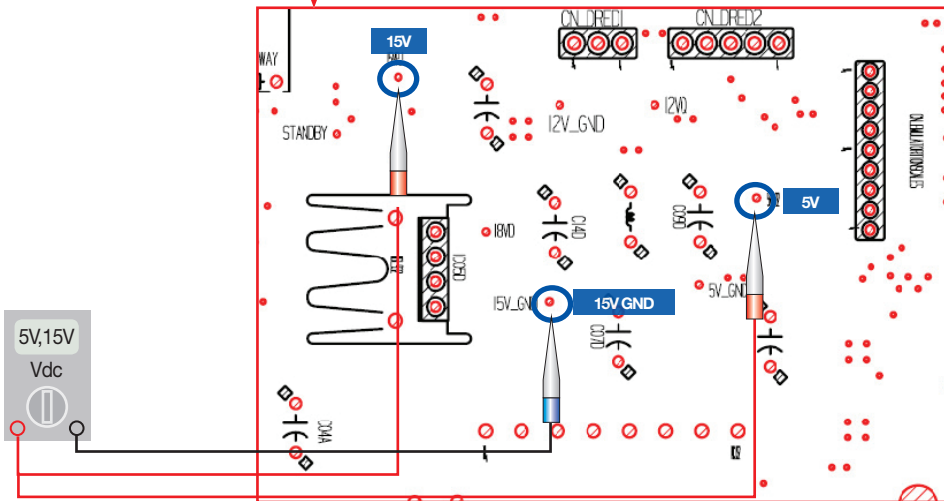

- ※ Be sure to pay attention as it is high pressure.
- Be sure to pay attention as it is high pressure.
- Wear insulated gloves and be careful skin does not contact PCBA

※ When measuring the bottom side, do it after scraping the coating gently.

C1-7. Detecting part Circuit check (1)

Detecting part circuit measurement method & Point-Type1

When error occurs, determine whether PCBA is normal by measuring point for confirmation.
After applying power, measure each point by multi meter Vdc.

If determined as abnormal, replace PCBA.

- (1) Input Current : CH22 may occur if the input current sensing circuit is abnormal. [Normal : 0~5V]
- (2) DC-Link : CH23 may occur if DC-Link voltage sensing circuit is abnormal. [Normal : 2.3~2.7V]
- (3) Comp Current : CH21 & CH29 may occur if Comp. current sensing circuit is abnormal. [Normal : 2.3~2.7V]

Enlargement of the actual product

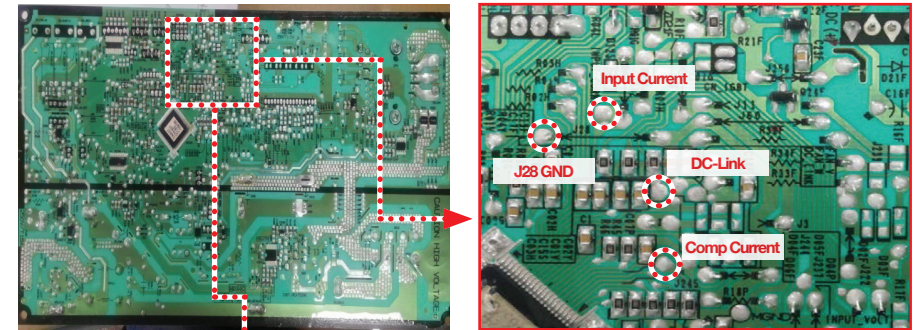

Drawing
Enlargement

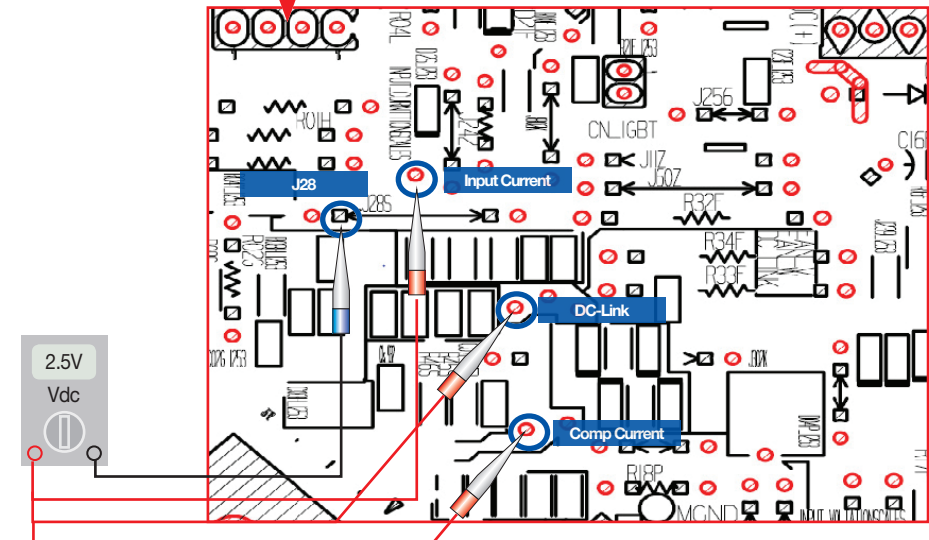

4. Appendix C (Electrical Part)



- ※ Be sure to pay attention as it is high pressure.
- Be sure to pay attention as it is high pressure.
- Wear insulated gloves and be careful skin does not contact PCBA

※ When measuring the bottom side, do it after scraping the coating gently.

C1-7. Detecting part Circuit check (2)

Detecting part circuit measurement method & Point-Type2

When error occurs, determine whether PCBA is normal by measuring point for confirmation.

After applying power, measure each point by multi meter Vdc.

Each point is normal between 2.3V ~ 2.7V —If determined as abnormal, replace PCBA.

(1)Input Current : CH22 may occur if the input current sensing circuit is abnormal.

(2)DC-Link : CH23 may occur if DC-Link voltage sensing circuit is abnormal.

(3)Comp Current : CH21 & CH29 may occur if Comp. current sensing circuit is abnormal.

Enlargement of the actual product

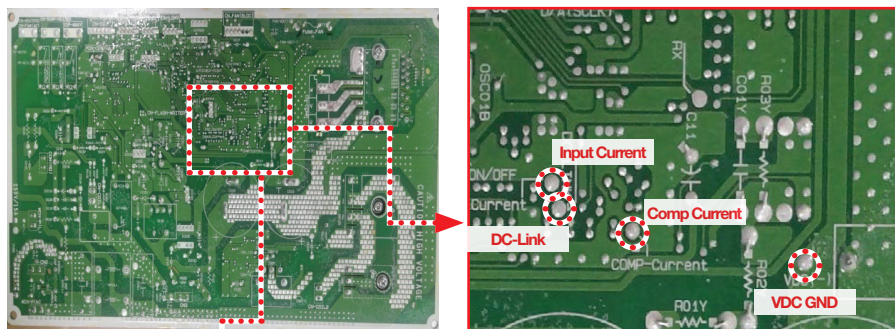

Drawing Enlargement

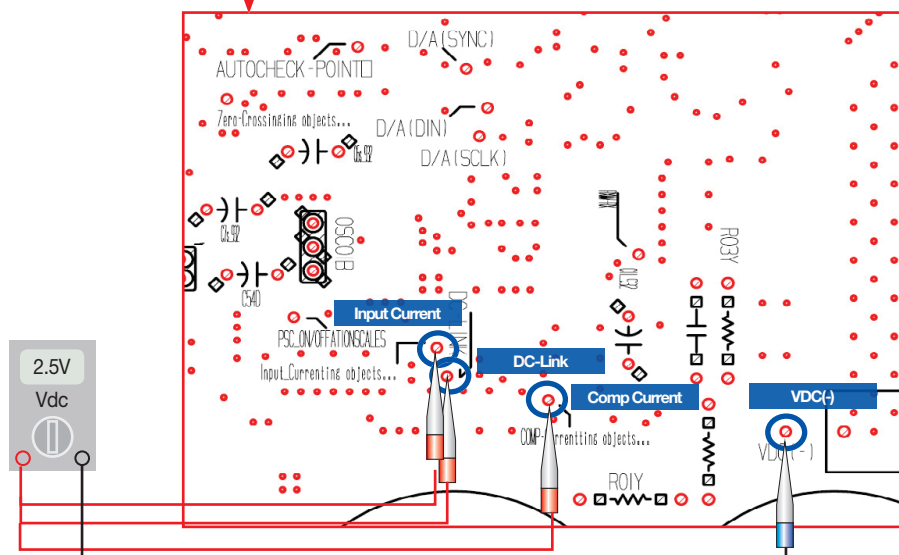

- ※ Be sure to pay attention as it is high pressure.
- Be sure to pay attention as it is high pressure.
- Wear insulated gloves and be careful skin does not contact PCBA

※ When measuring the bottom side, do it after scraping the coating gently.

C1-7. Detecting part Circuit check (3)

Detecting part circuit measurement method & Point-Type3

When error occurs, determine whether PCBA is normal by measuring point for confirmation.

After applying power, measure each point by multi meter Vdc.

Each point is normal between 2.3V ~ 2.7V —If determined as abnormal, replace PCBA.

(1)Input Current : CH22 may occur if the input current sensing circuit is abnormal.

(2)DC-Link : CH23 may occur if DC-Link voltage sensing circuit is abnormal.

(3)Comp Current : CH21 & CH29 may occur if Comp. current sensing circuit is abnormal.

Enlargement of the actual product

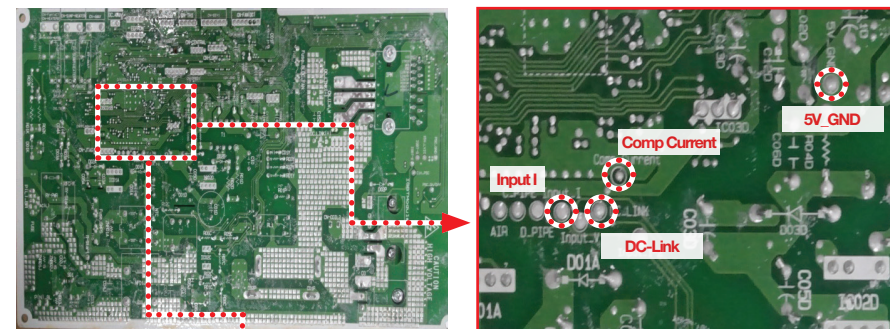

Drawing Enlargement

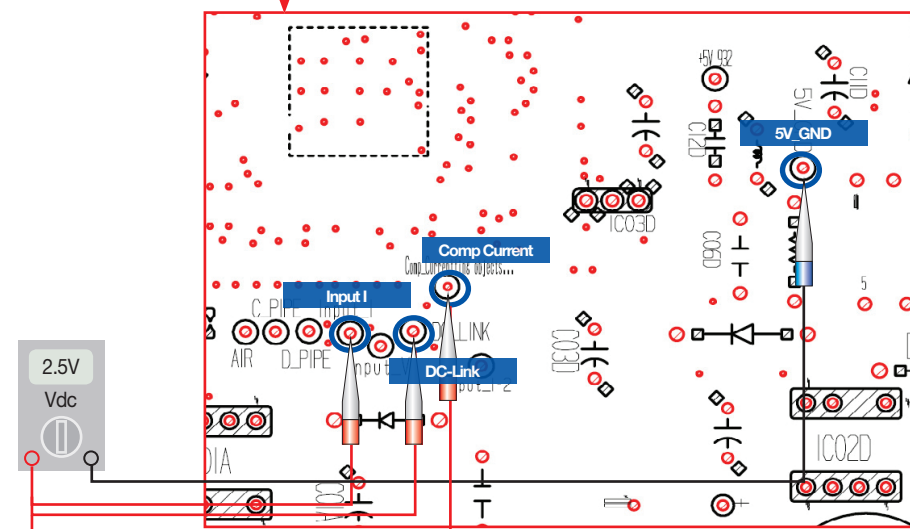

4. Appendix C (Electrical Part)



- ※ Be sure to pay attention as it is high pressure.
- Be sure to pay attention as it is high pressure.
- Wear insulated gloves and be careful skin does not contact PCBA

※ When measuring the bottom side, do it after scraping the coating gently.

C1-7. Detecting part Circuit check (4)

Detecting part circuit measurement method & Point-Type4

When error occurs, determine whether PCBA is normal by measuring point for confirmation.

After applying power, measure each point by multi meter Vdc.

Each point is normal between 2.3V ~ 2.7V → If determined as abnormal, replace PCBA.

(1) Input Current : CH22 may occur if the input current sensing circuit is abnormal.

(2) DC-Link : CH23 may occur if DC-Link voltage sensing circuit is abnormal.

(3) Comp Current : CH21 & CH29 may occur if Comp. current sensing circuit is abnormal.

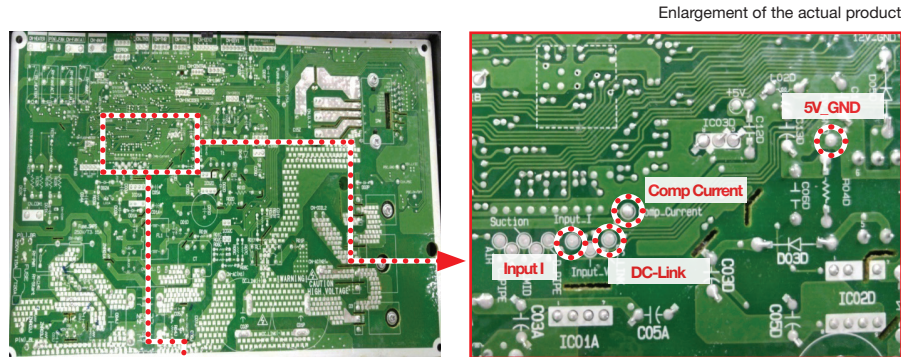

Enlargement of the actual product

Drawing
Enlargement

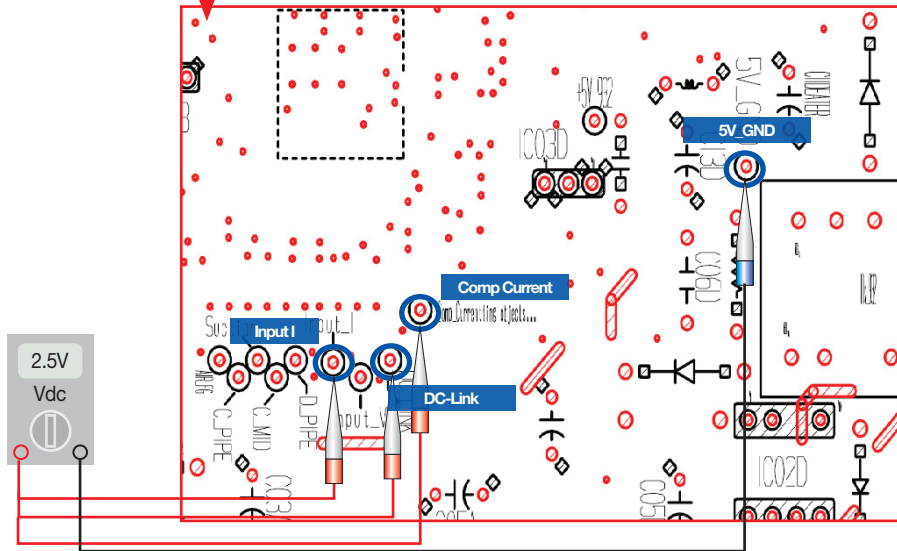

- ※ Be sure to pay attention as it is high pressure.
- Be sure to pay attention as it is high pressure.
- Wear insulated gloves and be careful skin does not contact PCBA

※ When measuring the bottom side, do it after scraping the coating gently.

C1-7. Detecting part Circuit check (5)

Detecting part circuit measurement method & Point-Type5

When error occurs, determine whether PCBA is normal by measuring point for confirmation.

After applying power, measure each point by multi meter Vdc.

Each point is normal between 2.3V ~ 2.7V → If determined as abnormal, replace PCBA.

(1) Input Current : CH22 may occur if the input current sensing circuit is abnormal.

(2) DC-Link : CH23 may occur if DC-Link voltage sensing circuit is abnormal.

(3) Comp Current : CH21 & CH29 may occur if Comp. current sensing circuit is abnormal.

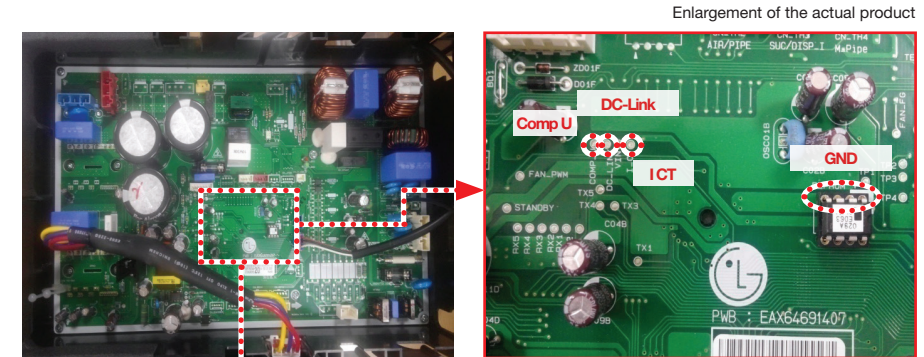

Enlargement of the actual product

Drawing
Enlargement

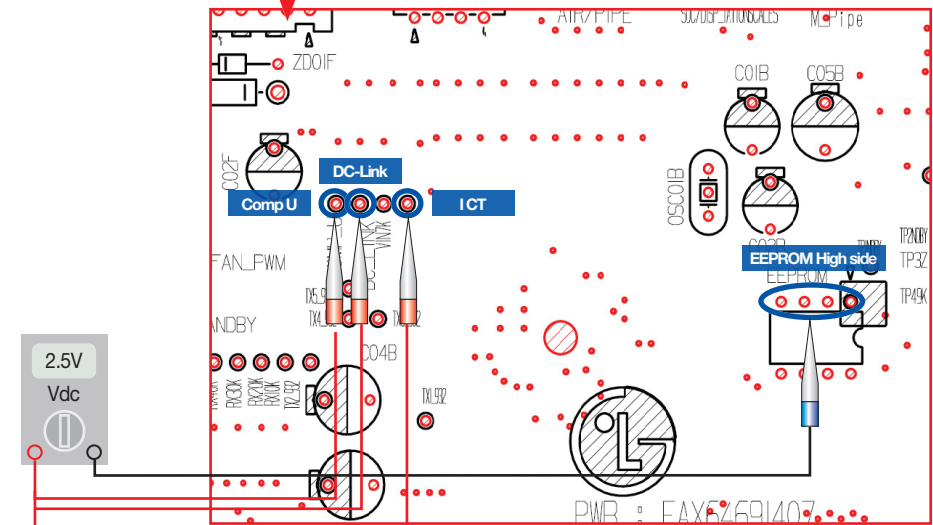

4. Appendix C (Electrical Part)



- ※ Be sure to pay attention as it is high pressure.
- Be sure to pay attention as it is high pressure.
- Wear insulated gloves and be careful skin does not contact PCBA

※ When measuring the bottom side, do it after scraping the coating gently.

C1-7. Detecting part Circuit check (6)

Detecting part circuit measurement method & Point-Type6

When error occurs, determine whether PCBA is normal by measuring point for confirmation.

After applying power, measure each point by multi meter Vdc.

Each point is normal between 2.3V ~ 2.7V → If determined as abnormal, replace PCBA.

(1) Input Current : CH22 may occur if the input current sensing circuit is abnormal.

(2) DC-Link : CH23 may occur if DC-Link voltage sensing circuit is abnormal.

(3) Comp Current : CH21 & CH29 may occur if Comp. current sensing circuit is abnormal.

Enlargement of the actual product

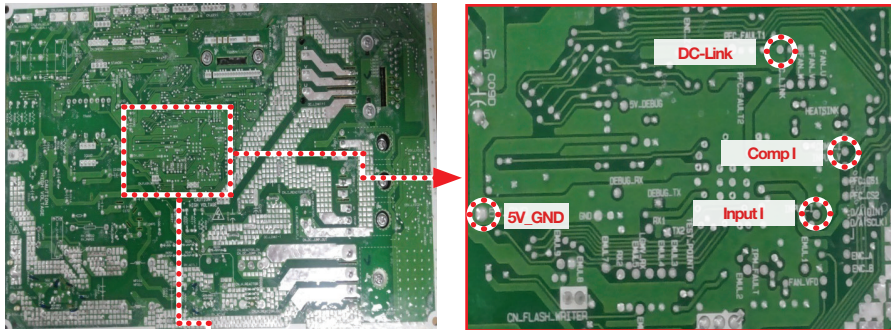

Drawing
Enlargement

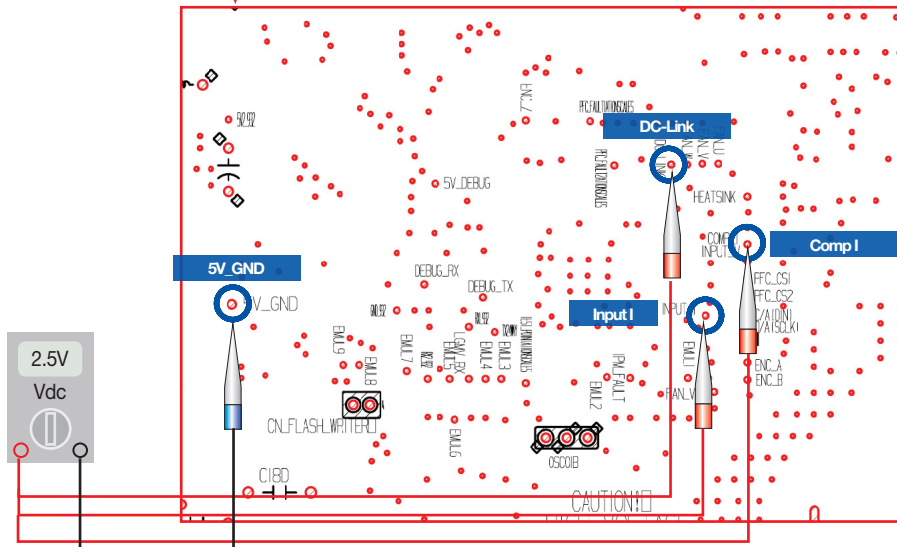

- ※ Be sure to pay attention as it is high pressure.
- Be sure to pay attention as it is high pressure.
- Wear insulated gloves and be careful skin does not contact PCBA

※ When measuring the bottom side, do it after scraping the coating gently.

C1-7. Detecting part Circuit check (7)

Detecting part circuit measurement method & Point-Type7

When error occurs, determine whether PCBA is normal by measuring point for confirmation.

After applying power, measure each point by multi meter Vdc.

Each point is normal between 2.3V ~ 2.7V → If determined as abnormal, replace PCBA.

(1) Input Current : CH22 may occur if the input current sensing circuit is abnormal.

(2) DC-Link : CH23 may occur if DC-Link voltage sensing circuit is abnormal.

(3) Comp Current : CH21 & CH29 may occur if Comp. current sensing circuit is abnormal.

Enlargement of the actual product

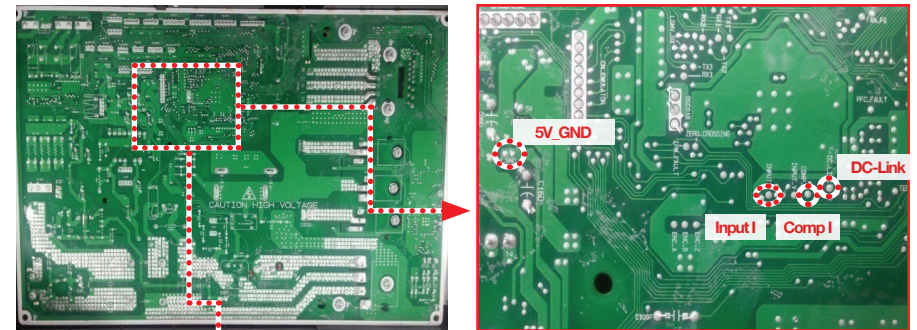

Drawing
Enlargement

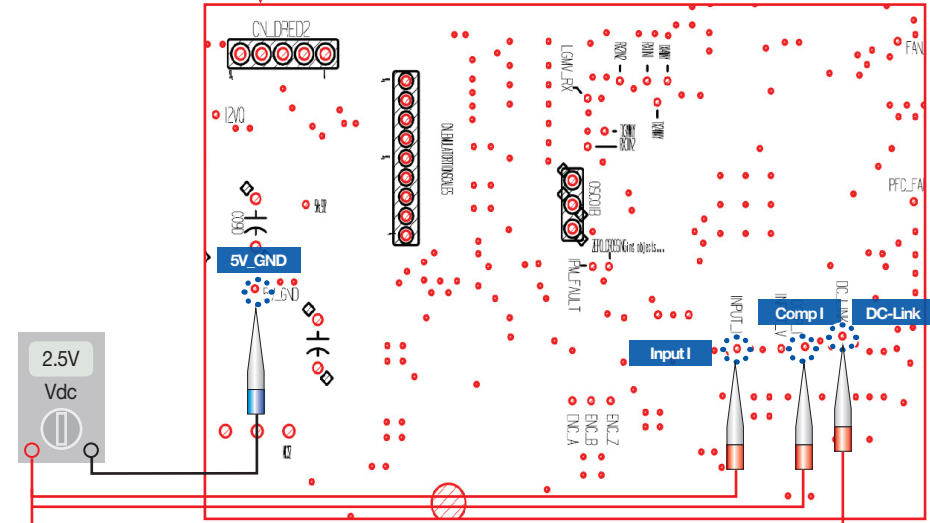

4. Appendix C (Electrical Part)

C1-8. DC-Link Check

Check DC-Link voltage using LG-MV, SIMS-Type common

INV.목표주파수(Hz)	Cond mid 온도	INV.토출온도	입력 전압[V]	입력 전류[A]	목표 Td	FAN1.목표 RPM	FAN2.목표 RPM
60	47.20	75.00	230	7.80	0	840	0
INV.현재주파수(Hz)	Inv.흡입 온도	Cond Out 온도	운전 모드	정속 입력전류[A]	현재 Td	FAN1.현재 RPM	FAN2.현재 RPM
60	-100.00	-	냉방	0.00	0	840	0
Q속 전류[A]	실외온도	Inv.Heatsink 온도	입력전압주파수	DC_LINK 목표전압[V]	실외_Main_LEV	Fan1 선간전압	Fan2선간전압
9.60	35.50	64.00	50	50	0	0	0
D속 전류[A]	Fan Heatsink 온도	소비전력[W]	DC_LINK 현재전압	실외기 유효압	Fan1상전류	Fan2상전류	
3.20	0	0.00	167.3	275	24	0.00	0.00
COMP 기준 STEP	현재 Step	계통군	ERROR CODE	통신시간[ms]	제기용 Timer	Fan1 Target Step	Fan2 Target Step
13	13	RAC	0	150	255	12	0
전류 ref.[A]	Q속 전류 ref.[A]	D속 전류 ref.[A]	Drive 유효	Converter Type	실내출간센서유무	EEPROM C/S High	EEPROM C/S Low
10.40	9.80	2.60	None	PSC	있음	0xe3	0x4d
DC Peak Cnt	DC_Link Low Cnt	Inv 기동실패 Cnt	중전류제한 Cnt	PFC/PSC Fault Cnt	Fan Lock Cnt	Inv.D-pipe_High Cnt	HeatSink 온도 Cnt
0	0	0	0	0	0	0	0
Comp 상전류 Cnt	C-Pipe High Cnt	고압 S/W Cnt	Comp 운전시간[sec]	Comp정시제어주기[se	EEV정시제어주기[sec	제상단계	습도[%]
0	0	0	255	45	0	0	0
Min Step	Max Step	Max 제한사유	설정온도치	EEV 정시중분	Comp PI중분	Comp 운전모드	EEV 운전모드
1	19	없음	8.20	0	2	정시	초기화(Full)
고압(kpa)	저압(kpa)	11P_148	11P_158	12P_68	12P_78	12P_148	12P_158
0	0	0	0	0	0	0	0

In normal PCBA, The value should be close to the value of the table below when power is applied.
 →When there comes out abnormal DC-Link output value, replace PCBA.
 When CH23 occurs, verify DC-Link voltage first through LG-MV, SIMS.
 →CH23 occurs when the voltage is below 140V or over 420V.

Type	Standard Value
Type1	290V
Type2	290V
Type3	290V
Type4	290V, 330V
Type5	380V
Type6	330V
Type7	380V

※ The standard value is different according to the model.



※ Be sure to pay attention as it is high pressure.
 → Be sure to pay attention as it is high pressure.
 → Wear insulated gloves and be careful skin does not contact PCBA

※ When measuring the bottom side, do it after scraping the coating gently.

C1-9. Communication Part 72V Check (1)

Communication part 72V-Type1, Type2

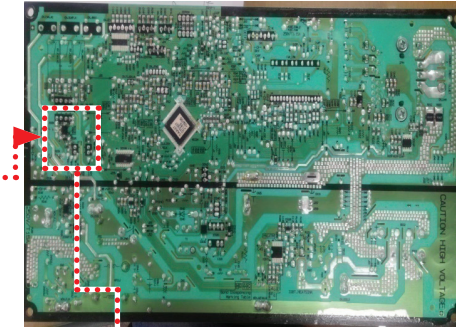
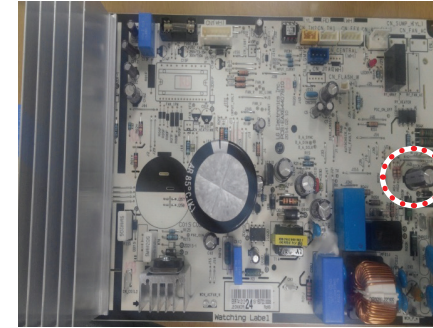

Enlargement of the actual product

Measure it under the power-on status.
 Measure with multi meter to **C02K** at the back side of PCBA.
 Measure it by touching red Probe to Remark straight line and black Probe to the curve as shown on the photograph.
 Judge it as normal if it is in the range of 69~75V with 72V ± 5%.
 →In case of abnormal output, replace PCBA.

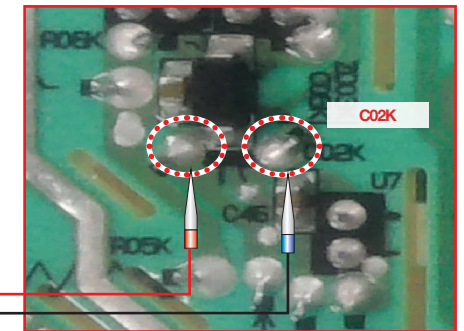

Communication part 72V-Type5

Measure it under the power-on status.
 Measure with multi meter to the ends of **R03A** at the front side of PCBA.

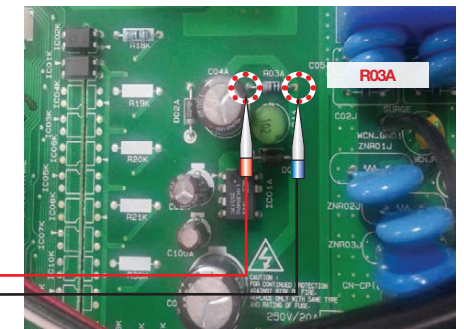

4. Appendix C (Electrical Part)



- ※ Be sure to pay attention as it is high pressure.
- Be sure to pay attention as it is high pressure.
- Wear insulated gloves and be careful skin does not contact PCBA

※ When measuring the bottom side, do it after scraping the coating gently.

C1-9. Communication Part 72V Check (2)

Communication part 72V-Type3, Type4, Type6, Type7

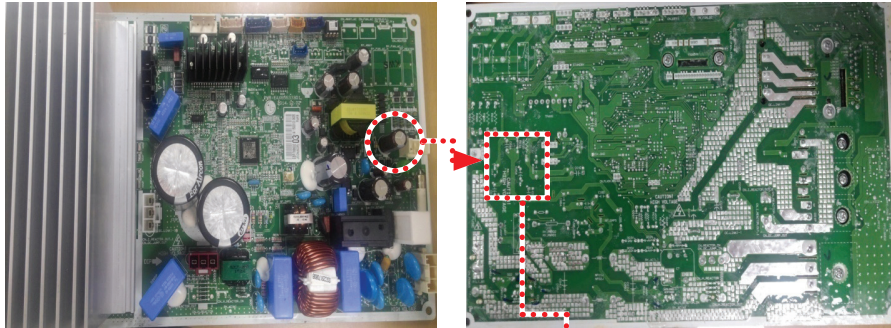

Enlargement of the actual product

Measure it under the power-on status.
 Measure with multi meter to C02K at the back side of PCBA.
 Measure it by touching red Probe to Remark straight line and black Probe to the curve as shown on the photograph.
 Judge it as normal if it is in the range of 69~75V with 72V ± 5%.
 →In case of abnormal output, replace PCBA.

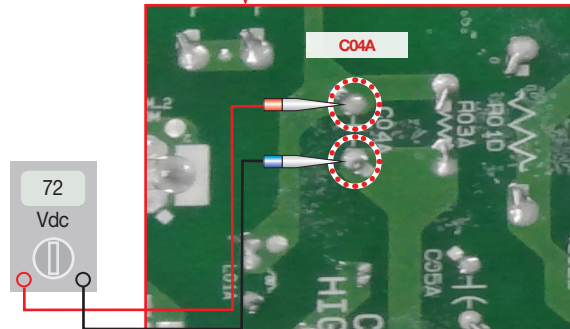

C1-10. IPM Check (1)

Way to check IPM-Type Common

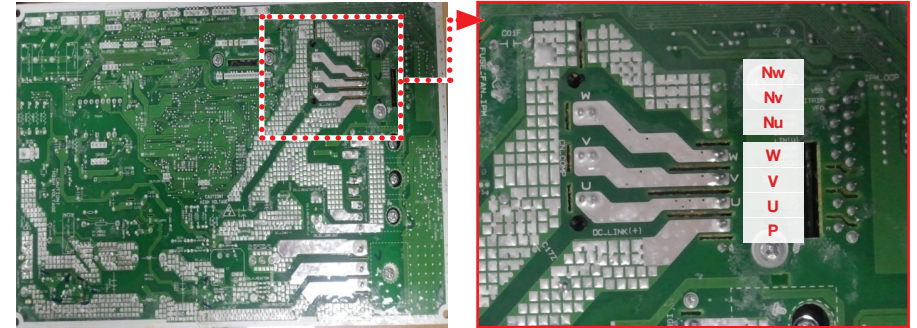

Enlargement of the actual product

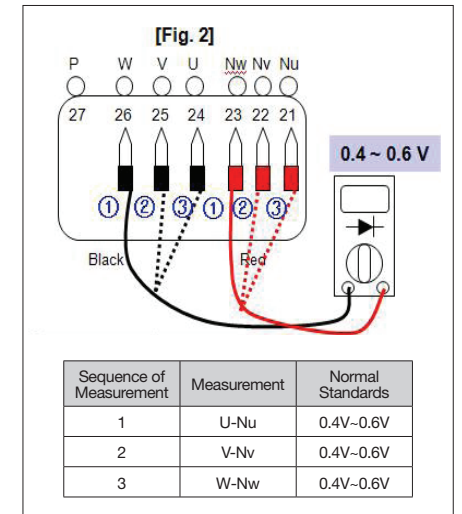
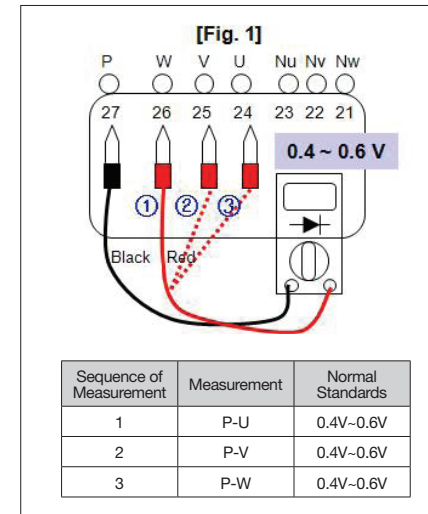

To verify the internal burn-out of the IPM, measure Diode between P part and UVW phase. Then, measure Diode between N part and UVW.

After measurement, if the measured value exists between 0.4~0.6V, judge it as normal.

Verify additionally whether the remaining pins became short.

→If the measured value deviates from the normal value or if it becomes short, CH21 occurs immediately.

If it is judged as abnormal, replace PCBA.

※ If touched one side by Node whose Nu, Nv, Nw is same, UVW can be measured.

※ When measuring the bottom side, do it after scraping the coating gently.

4. Appendix C (Electrical Part)

※ When measuring the bottom side, do it after scraping the coating gently.

C1-10. IPM Check (2)

IPM measuring Point for each type

<Type1>

Enlargement of the actual product

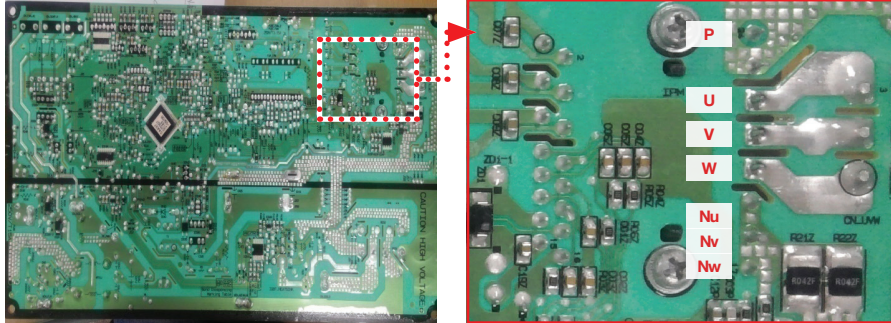

<Type2, Type3, Type4, Type6, Type7>

Enlargement of the actual product

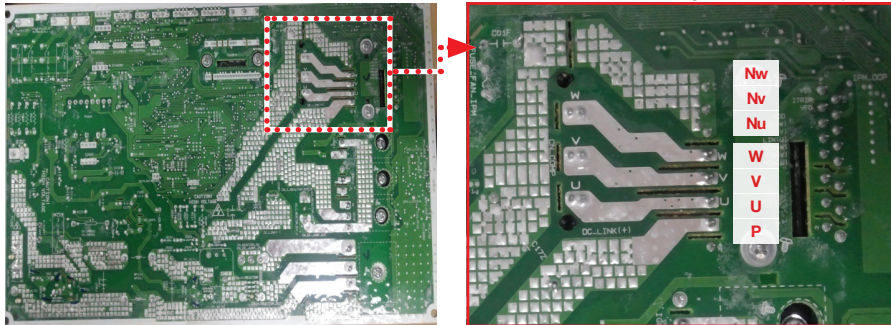

<Type5>

Enlargement of the actual product

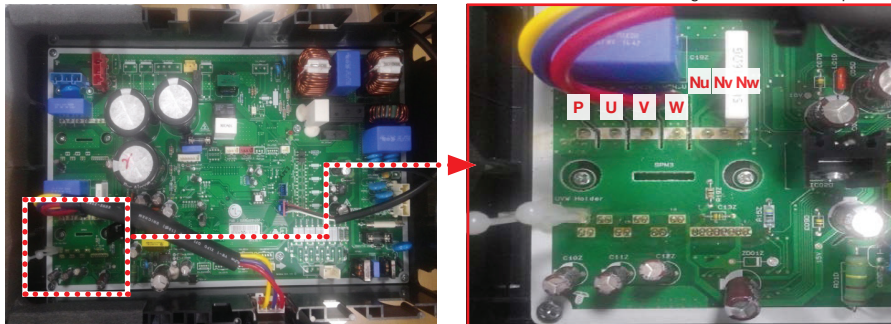

※ When measuring the bottom side, do it after scraping the coating gently.

C1-11. External type Fan IPM Check (1)

Check Fan IPM of External type-Type6

Enlargement of the actual product

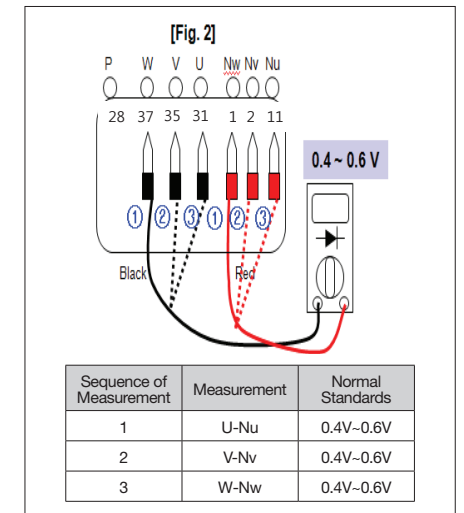
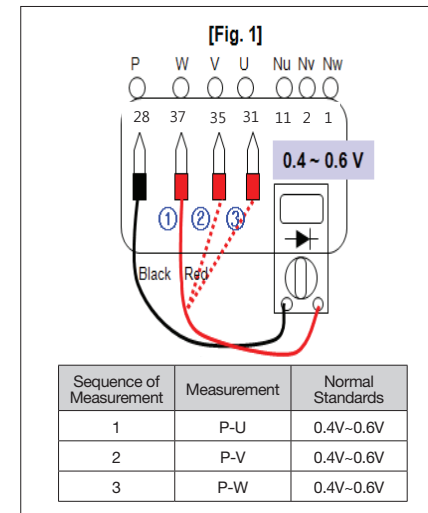
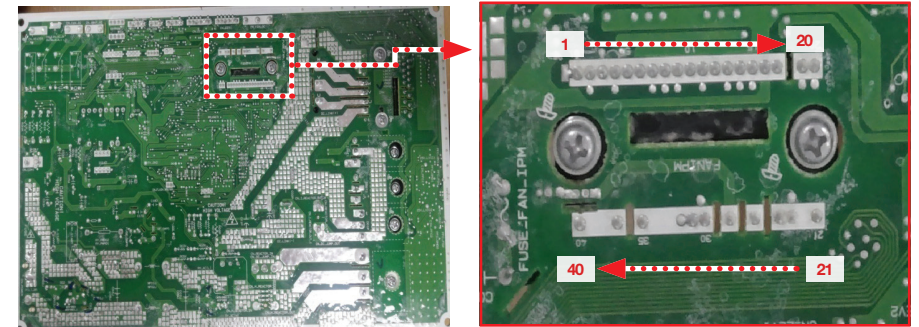

To verify the internal burn-out of the Fan IPM, measure Diode between P part and UVW phase. Then, measure Diode between Nu, Nv, Nw part and UVW. After measurement, if the measured value exists between 0.4~0.6V, judge it as normal.

Verify additionally whether the remaining pins became short.

—If the measured value deviates from the normal value or if it becomes short, CH67 occurs immediately.

—If Fan IPM was burnt out, Fan Fuse may be burnt out.

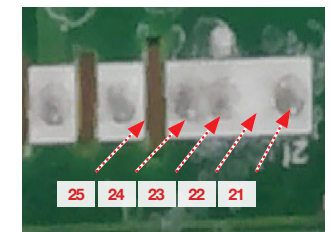

4. Appendix C (Electrical Part)

※ When measuring the bottom side, do it after scraping the coating gently.

C1-12. PFCM Check

PFCM Diode normality check-Type5

Enlargement of the actual product

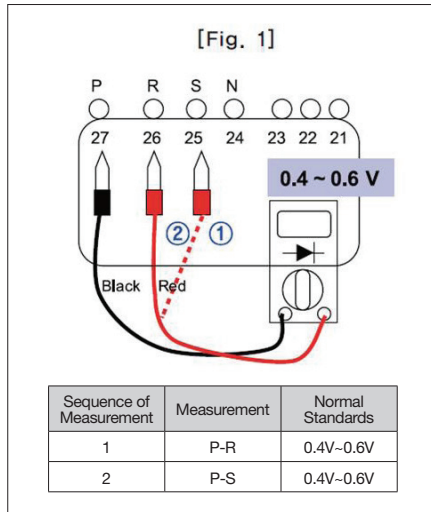
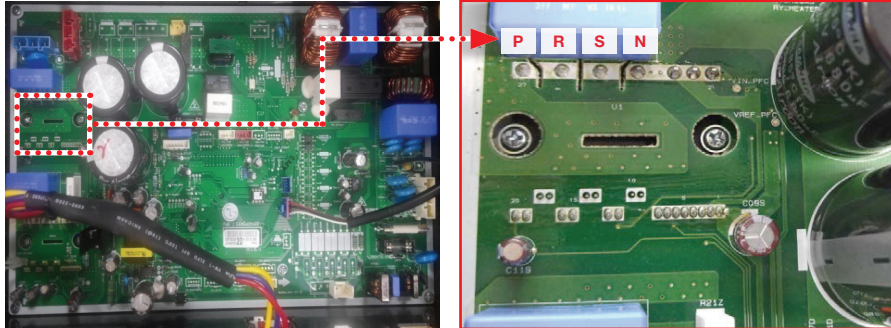

When CH27 occurs, measure each Diode value of PFCM as the above method. If the measured values is abnormal, replace PCBA.

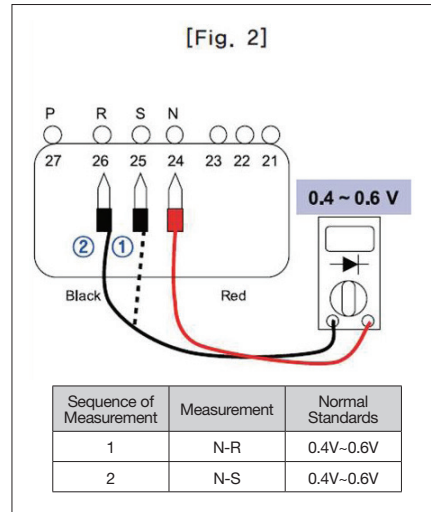

※ In case of old model, it may occur intermittently, but in case of new model, CH27 does not occur.

C1-13. Heat-Sink Check

Heat-Sink Screw Tightening check - Type Common

When the corresponding screw below was not tightened well, CH62 may occur. If error occurs, fasten the corresponding point firmly with the drive

Type Common Bottom

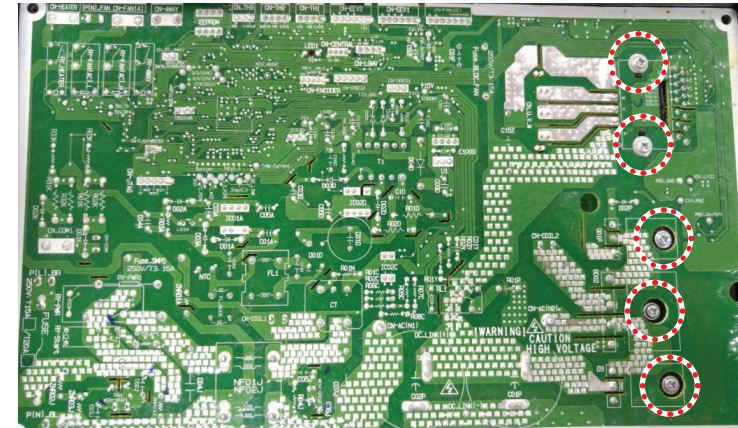

Type5 Top

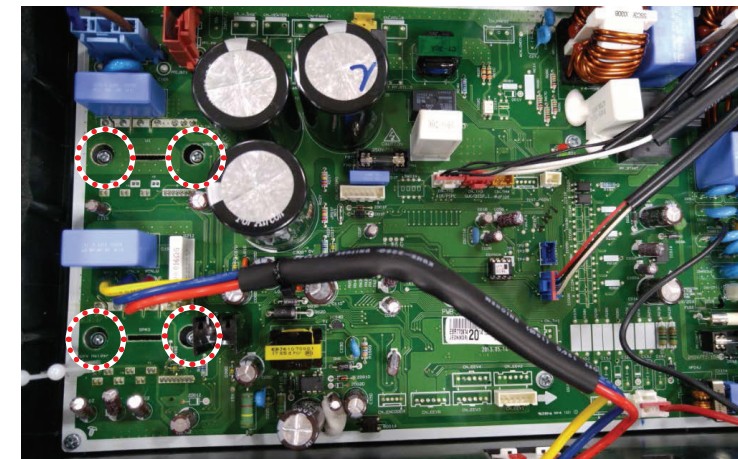

4. Appendix C (Electrical Part)

※ When measuring the bottom side, do it after scraping the coating gently.

C2. Sensor

C2-1. Air / Pipe Sensor Check

Sensor Resistance check

Measure the resistance of the sensor ends with the resistance measuring mode of the multi meter. When measuring room temperature, refer to the measuring point and value of the followings, and for detailed sensor table, refer to APP.

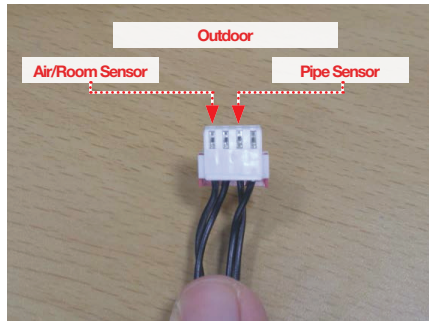
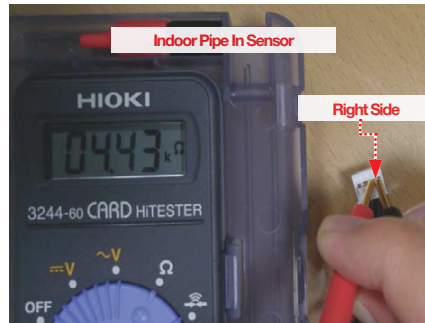

[Table] at 25°C, ±10%

In/Out door	Value	Error
Air/Room	10kΩ	Indoor : CH01 Outdoor : CH44
Pipe	5kΩ	Indoor : CH02 Outdoor : CH45

In addition, in case of the single sensor also, measure the sensor ends resistance value with resistance measuring mode.

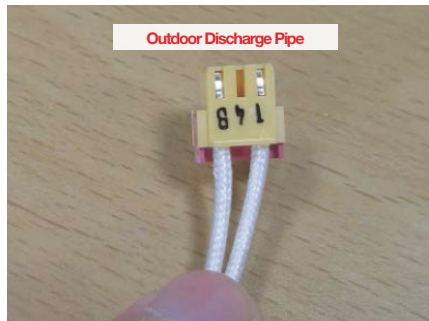

[Table] at 25°C, ±10%

Indoor	Value	Error
Pipe Out Sensor	5kΩ	CH06
Pipe Mid Sensor	5kΩ	CH12
Outdoor	Value	Error
Discharge Pipe	200kΩ	CH41
Heat-sink Sensor	10kΩ	CH65

C2-2. Pressure Sensor Check

Sensor Resistance check

Measure the resistance value between each pins with the resistance value measuring mode of the multi meter.

When measuring room temperature, judge it whether it is normal referring to the measuring point and value of the followings.

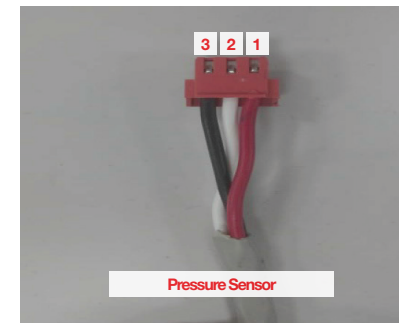

[Table]

	Value
No.1- No.3	90kΩ ± 10%
No.2 -No. 3	≥ 5MΩ
No.1 -No. 2	≥ 15MΩ

4. Appendix C (Electrical Part)

C2-3. In/Outdoor Sensor resistance Table (1)

• Outdoor Unit Sensor

Temperature		Pipe Sensor		D-Pipe sensor(InV Td)		Air Sensor	
°C	°F	Resistance (kΩ)	Voltage (V)	Resistance (kΩ)	Voltage (V)	Resistance (kΩ)	Voltage (V)
-30	-22	102.2	4.71	-	-	204.3	4.72
-25	-13	73.5	4.60	-	-	147.0	4.62
-20	-4	53.5	4.47	-	-	107.1	4.49
-15	5	39.5	4.31	-	-	79.0	4.34
-10	14	29.5	4.12	-	-	59.0	4.15
-5	23	22.2	3.90	-	-	44.5	3.93
0	32	17.0	3.65	586	4.85	33.9	3.68
5	41	13.0	3.38	465	4.81	26.1	3.42
10	50	10.1	3.10	372	4.77	20.3	3.13
15	59	7.9	2.80	301	4.72	15.9	2.84
20	68	6.3	2.51	244	4.66	12.6	2.55
25	77	5.0	2.23	200	4.59	10.0	2.26
30	86	4.0	1.97	165	4.51	8.0	1.99
35	95	3.2	1.72	137	4.42	6.5	1.74
40	104	2.6	1.50	114	4.32	5.3	1.52
45	113	2.2	1.30	96	4.21	4.3	1.32
50	122	1.8	1.12	81	4.09	3.6	1.14
55	131	1.5	0.97	68	3.96	3.0	0.98
60	140	1.2	0.84	58	3.82	2.5	0.85
Tolerance		± 30%	± 10%	± 30%	-	± 30%	± 10%

• Indoor Unit Sensor

Temperature		Pipe Sensor		Air Sensor	
°C	°F	Resistance (kΩ)	Voltage (V)	Resistance (kΩ)	Voltage (V)
0	32	16.8	3.65	33.9	3.68
5	41	13.0	3.38	26.1	3.42
10	50	10.1	3.10	20.3	3.13
15	59	7.9	2.80	15.9	2.84
20	68	6.3	2.51	12.6	2.55
25	77	5.0	2.23	10.0	2.26
30	86	4.0	1.97	8.0	1.99
35	95	3.3	1.72	6.5	1.74
40	104	2.7	1.50	5.3	1.52
45	113	2.2	1.30	4.3	1.32
50	122	1.8	1.12	3.6	1.14
55	131	1.5	0.97	3.0	0.98
60	140	1.2	0.84	2.5	0.85
Tolerance		-	± 10%	-	± 10%

		Resistance @25°C
Outdoor	Pipe	5.0
	Air	10.0
	D-Pipe	200.0
Indoor	Pipe	5.0
	Air	10.0

UNIT : kΩ

C2-3. In/Outdoor Sensor resistance Table (2)

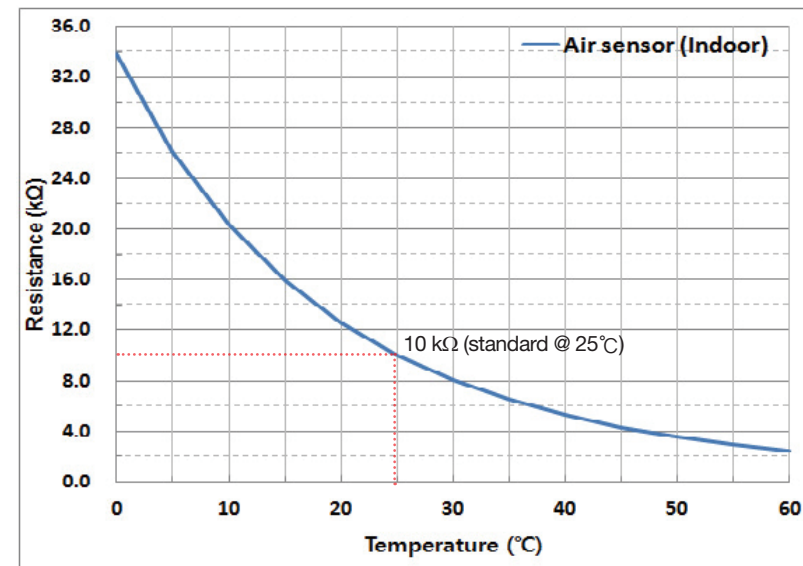
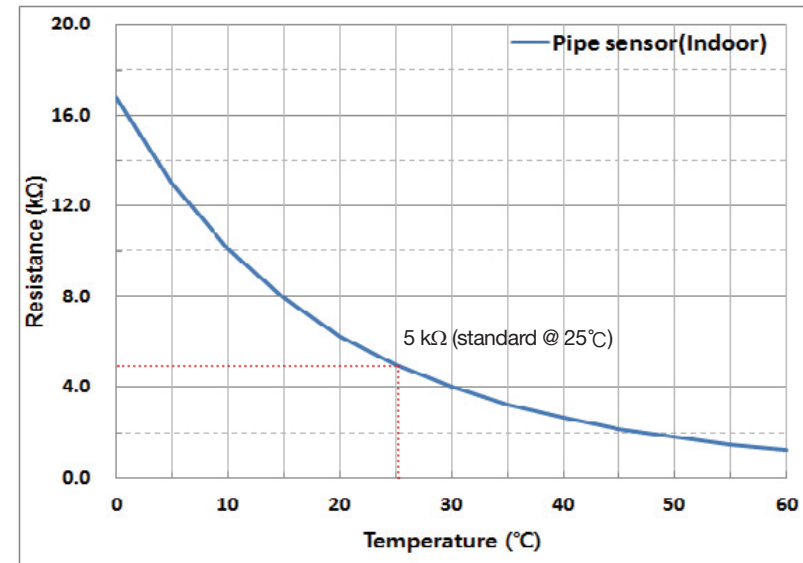

4. Appendix C (Electrical Part)

C2-3. In/Outdoor Sensor resistance Table (3)

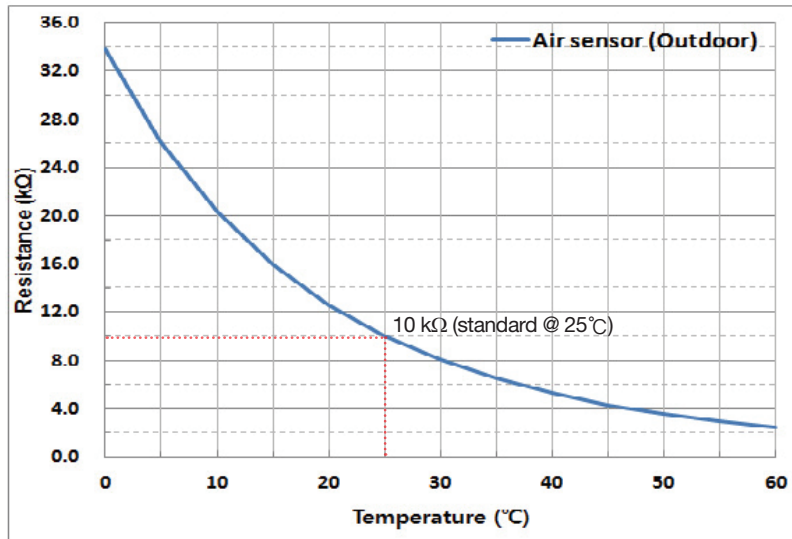
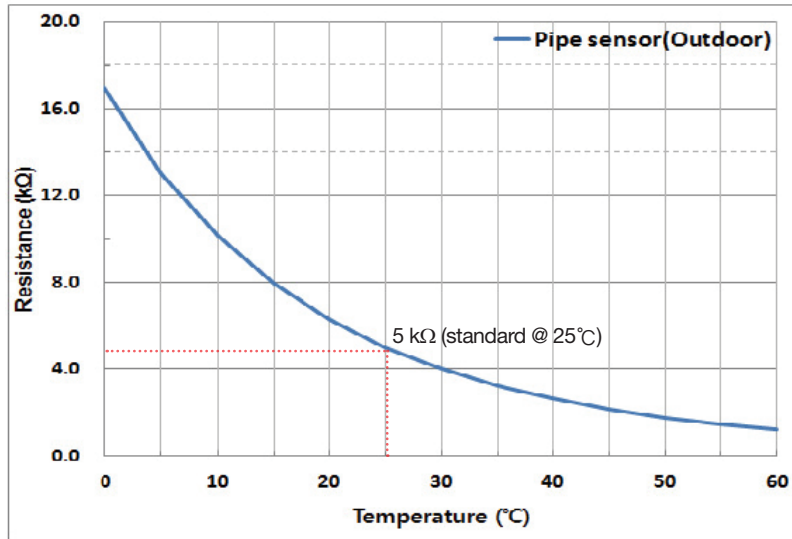

C2-3. In/Outdoor Sensor resistance Table (4)

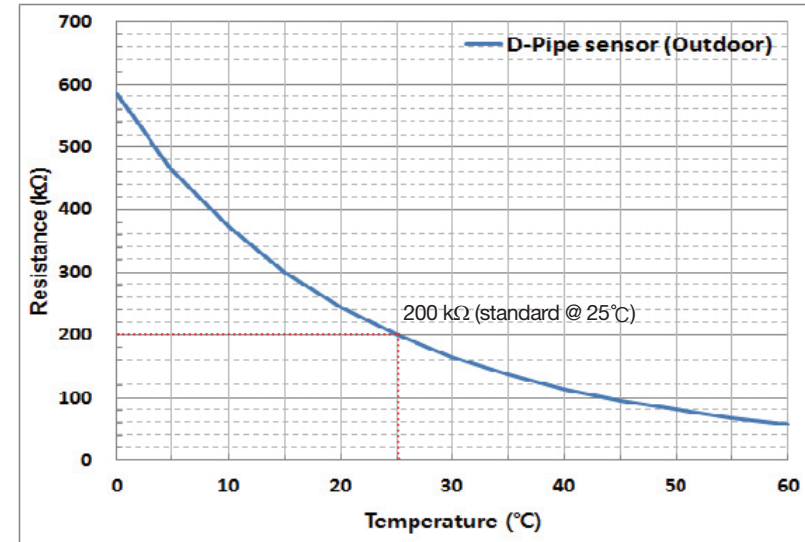

4. Appendix C (Electrical Part)

C3. Compressor

C3-1. Check insulation between Compressor and Pipe

After checking insulation between compressor and pipe, if the compressor resistance value is abnormal, replace compressor.

Measure the resistance between Compressor harness and pipe surface with multi meter.

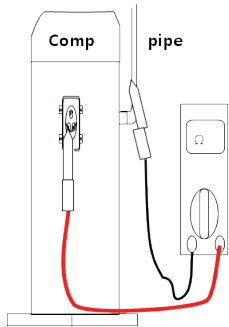

- ※ It is possible to remove the compressor harness and measure the resistance between each phase of the compressor and pipe directly.
- ※ When measuring, judge the resistance value after waiting number of seconds after placing multi meter.
- ※ When the insulation between compressor and pipe is broken, PCBA may be burn out. So, in case of PCBA, check it referring to the measuring method of IPM.

Measuring point	Normal value
U - Pipe	$\geq 10M\Omega$
V - Pipe	$\geq 10M\Omega$
W - Pipe	$\geq 10M\Omega$

C3-2. Check Compressor Line Resistance

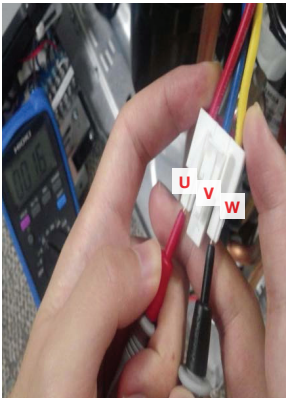
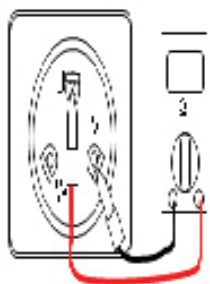

- ※ It is possible to remove the compressor harness and measure the resistance between each lines.
- ※ When measuring, judge the resistance value after waiting number of seconds after placing multi meter.

Comp. Line Resistance	
U - V	0.5 ~ 3.0 Ω
V - W	0.5 ~ 3.0 Ω
W - U	0.5 ~ 3.0 Ω

※ Refer to the line resistance value for compressor type.

GA092		GA102						GKT128	GKT141	GKT176	GJT240	5RS		DA128A
MA	MC	MA	MB	MD	MF	MK	MA	MB	MF	MB	102XAA	132Z	20F	
2.56	1.95	1.59	1.73	1.07	1.08	2.06	1.13	1.54	1.14	0.63	1.31	0.80	1.31	

C4. Motor

C4-1. BLDC Motor

BLDC Motor Diode Measurement check

Inspect indoor and outdoor BLDC motor and replace BLDC motor when it is abnormal. When measuring, set No. 1 and No. 4 of BLDC motor as multi meter Diode mode and judge it as normal in the range of 0.8V ~ 1.2V.

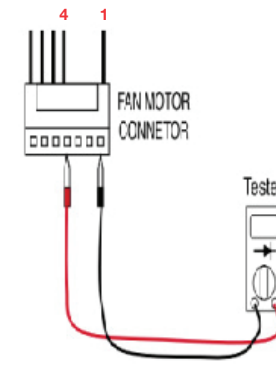

- ※ When measuring, judge the voltage value of the diode after waiting number of seconds after placing multi meter.
- ※ It is measurable only when the red Probe of the multi meter contacts No.4 pin of the motor, and when the black Probe contacts No.1 pin of the motor.

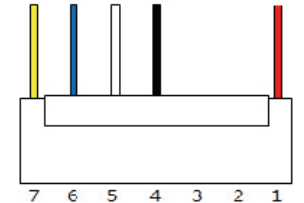

BLDC Motor Resistance measurement check

Measure the resistance value with the following point. If the unit of the measuring value becomes different or when it comes out Open, Short, judge it as abnormal and replace the motor.(The value is different depending on the maker and the motor type.)

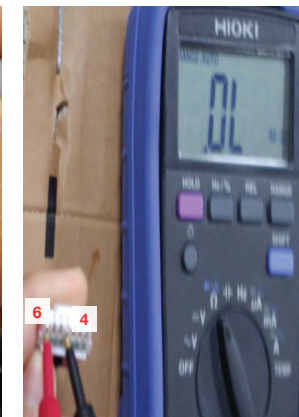

BLDC Motor line resistance		
No,1 - No,4		Open
No,4 - No,5		$\geq 1K\Omega$
No,4 - No,6		Open
No,4 - No,7		$\geq 50K\Omega$

- ※ When measuring the resistance value between lines, the black Probe of the multi meter should contact No. 4 pin.

4. Appendix C (Electrical Part)



※ Be sure to pay attention as it is high pressure.
 → Be sure to pay attention as it is high pressure.
 → Wear insulated gloves and be careful skin does not contact PCBA

※ When measuring the bottom side, do it after scraping the coating gently.

C4-2. AC-Motor

AC-Motor PCBA Output check

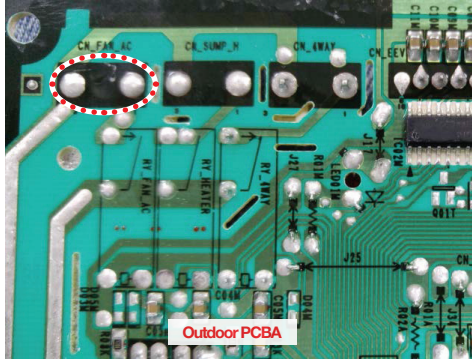

After starting up the compressor at PCBA, measure the voltage between PCBA CN_FAN_AC .

If the value is input voltage(220V) ± 10% , judge it as normal →Replace PCBA if it is abnormal.

If AC-Motor does not operate under the normal PCBA output, replace AC-Motor.

Outdoor PCBA

AC-Motor Resistance Measurement Check

When measuring indoor and outdoor AC-Motor, measure the resistance value of both AC-Motor pin with multi meter resistance measuring mode.

Indoors : Main(Orange – Black), Sub(Yellow – Black)

Outdoors : Main(Yellow – Blue), Sub(Yellow – Red)

Refer to the table below.



Indoor AC-Motor

[Table]

Mearsurement Pin	Normal Standard
Main(ORG-BLK)	300Ω ~ 600Ω
Sub(YEL-BLK)	600Ω ~ 900Ω



Outdoor AC-Motor

[Table]

Mearsurement Pin	Normal Standard
Main(YEL-BLU)	200Ω ~ 600Ω
Sub(YEL-Red)	200Ω ~ 600Ω

※The motor resistance value is different depending on the temperature and the maker.

C4-3. Exterior fan Motor

External Fan Motor Resistance Measurement check

Separate PCBA and External fan motor connector and measure the resistance value of the connector 3 phase of the external fan motor with multi meter resistance measuring mode. If the measurement value is $51.5\Omega \pm 2.6\Omega$ or $76.8\Omega \pm 3.8\Omega$ at 20°C, judge it as normal. (The approval resistance value is different with the maker)

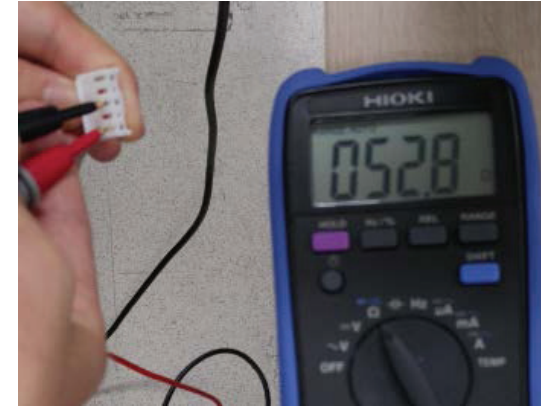

[Table]

Measurement Pin	Normal Standard
RED – BLUE	$51.5\Omega \pm 2.6\Omega$ or $76.8\Omega \pm 3.8\Omega$
BLUE – YELLOW	$51.5\Omega \pm 2.6\Omega$ or $76.8\Omega \pm 3.8\Omega$
YELLOW - RED	$51.5\Omega \pm 2.6\Omega$ or $76.8\Omega \pm 3.8\Omega$

4. Appendix C (Electrical Part)

C5. 4-way valve

4-way Resistance Measurement check

Measure the resistance value of the both 4-way pin with multi meter resistance measuring mode. If the measurement value is $21K\Omega \pm 20\%$, judge it as normal



- ※ Be sure to pay attention as it is high pressure.
- Be sure to pay attention as it is high pressure.
- Wear insulated gloves and be careful skin does not contact PCBA
- ※ When measuring the bottom side, do it after scraping the coating gently.

4-way PCBA output check

After operation of heating mode, measure the voltage across the PCBA Connector. If the rated voltage is $220V \pm 10\%$, judge PCBA as normal.
 —If heating mode is not operated under the PCBA normal output, replace 4-way.

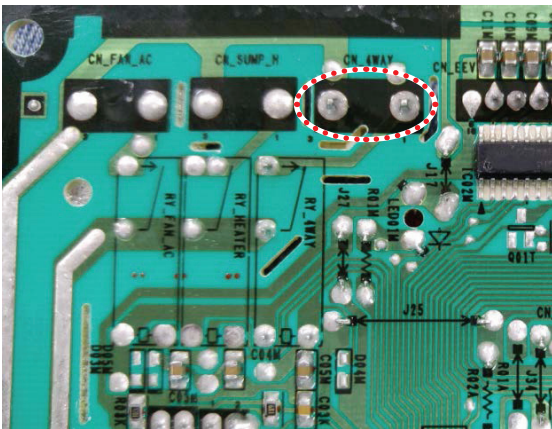

C6. EEV

EEV Resistance Measurement check

Measure the resistance value of each EEV pin with multi meter resistance measuring mode. Judge the normality referring to the value of the table below.

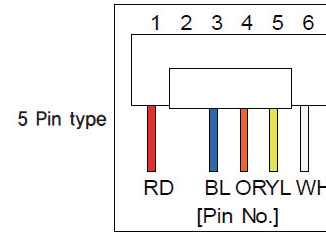

[Table]

Mearsurement Pin	Normal Standard
No,1 - No,3	$45\Omega \pm 5\Omega$
No,1 - No,4	$45\Omega \pm 5\Omega$
No,1 - No,5	$45\Omega \pm 5\Omega$
No,1 - No,6	$45\Omega \pm 5\Omega$

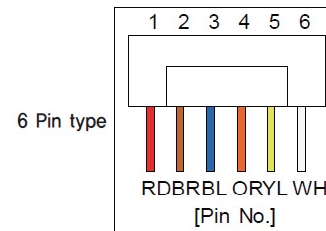

[Table]

Mearsurement Pin	Normal Standard
No,1 - No, 3	$45\Omega \pm 5\Omega$
No,1 -No, 5	$45\Omega \pm 5\Omega$
No,2 -No, 4	$45\Omega \pm 5\Omega$
No,2 -No, 6	$45\Omega \pm 5\Omega$

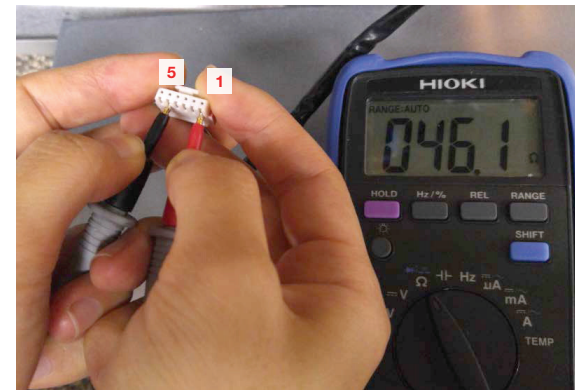

- ※ There may be some value difference depending on the type of the EEV.

4. Appendix C (Electrical Part)

C7. Etc.

C7-1. Sump-Heater

Sump_Heater Resistance Measurement check

Measure the resistance value of the both sump heater pin with multi meter resistance measuring mode.

If the measurement value is $800K\Omega \pm 20\%$, judge it as normal.



C7-2. Reactor Connection

Reactor PCBA Fastening check - Type common

Check whether reactor is connected by measuring whether the both fastening parts of PCBA reactor became to be short by multi meter under power-off.

Measure the both ends of CN_Coil1 & CN_Coil2, and it is normal if they become to be short.

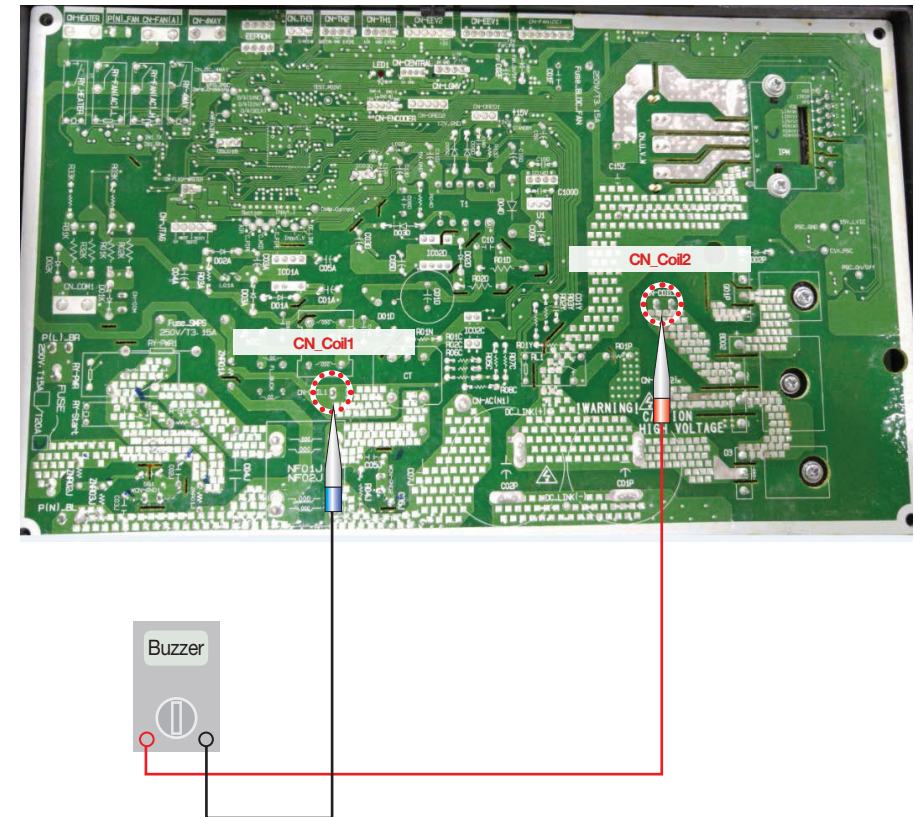

4. Appendix C (Electrical Part)

C7-3. Communication Line

Check the resistance of the connecting wires

Measure the resistance value of the both ends of the same-color connecting wire with the multi meter resistance measurement mode.

Be sure to wear the insulating gloves when measuring it and if there is no insulating gloves, measure it by twisting the wire to the Probe Pin to prevent human's hands from touching it. (If touched by both hands, human's resistance is measured.)

When measuring resistance, the resistance value may vary according to the wire length, however the low value (below 1Ω) should be measured.

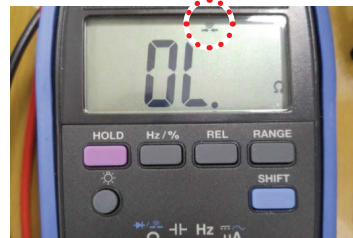

※ Short can be checked by measuring the sound mode.

Also, it should be open when measuring the both ends of the connecting wires with each different colors.

Check each connecting status of L - N, L - C, L - G, N - C, N - G, C - G Line.

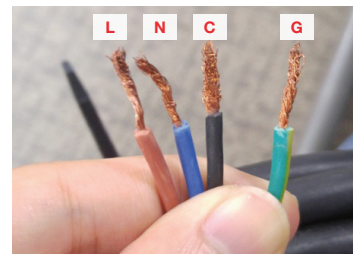

※ they must be opened

C7-4. Main & Terminal Line, Comp Harness

Main power wire & Terminal Jump wire check

Check whether the both ends of the same-color connecting wire is short with multi meter resistance sound mode.

When measuring the main power wire, let L,N wire contact No. 1 & No. 2 Plug in turn as it is hard to discriminate Plug and L,N wire.

When contact, consent plug and L, N wire should be matched 1 : 1.

For jump wire, check whether the color connecting wire is short with sound mode, and if brown wire is open, check whether the fuse is burnt out.

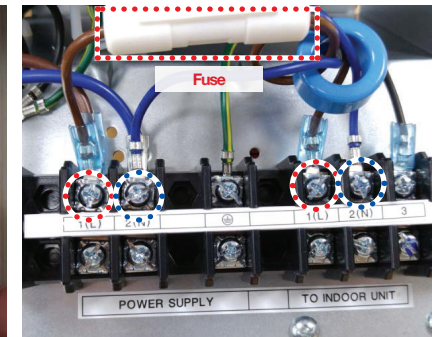
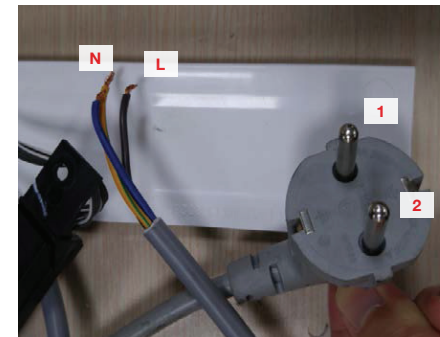

Comp. Wire check

Separate the Comp. Wire line and check whether the both ends of the same-color connecting wire is short with multi meter resistance sound mode.

If there is short between different-color wires, replace the hardness.

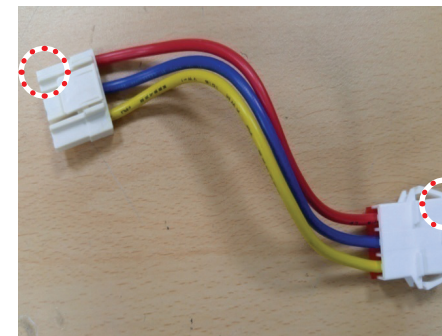



Copyright © 2015 LG Electronics. all Rights Reserved.

Address LG Electronics Inc, 84, Wanam-ro, Seongsan-gu,
Changwon-si, Gyeongsangnam-do, Korea

Printed in Korea December, 2015

The specifications, designs, and information in this brochure are subject to change without notice.