

SERVICE MANUAL

AIR CONDITIONER

Please read this manual carefully before operating your set and retain it for future reference.

Applied(AHU)
COMMUNICATION KIT
PAHCMR000, PAHCMS000

Copyright © 2017 LG Electronics Inc. All rights reserved. Only training and service purposes.

P/NO : MFL70041201

www.lg.com



TABLE OF CONTENTS

Safety Precautions	3
Standards for Model	6
Functions & Accessory	7
Wiring Diagram	8
Disassembly Diagram (Deal Drawing)	9
Troubleshooting	13





Safety Precautions

To prevent injury to the user or other people and property damage, the following instructions must be followed.





- Incorrect operation due to ignoring instruction will cause harm or damage. The seriousness is classified by the following indications.

 WARNING	This symbol indicates the possibility of death or serious injury.
 CAUTION	This symbol indicates the possibility of injury or damage to properties only.





- Meanings of symbols used in this manual are as shown below.





	Be sure not to do.
	Be sure to follow the instruction.
	Dangerous Voltage
	Be sure to provide grounding.

1.1 Cautions in Repair





 WARNING	
Be sure to disconnect all remote electric power supplies before servicing. Internal components and circuit boards are at main potential when the equipment is connected to the power cables. This voltage is extremely dangerous and may cause death or severe injury if come in contact with it.	
When removing the front panel or cabinet, execute short-circuit and discharge between high voltage capacitor terminals. If discharge is not executed, an electric shock is caused by high voltage resulted in a death or injury.	
Be sure to provide the grounding when repairing the equipment in a humid or wet place, to avoid electrical shocks.	





Safety Precautions

<p>Do not use a defective or underrated circuit breaker. Use the correctly rated breaker and fuse. Otherwise there is a risk of fire or electric shock.</p>	
<p>Install the panel and the cover of control box securely. Otherwise there is risk of fire or electric shock due to dust, water etc.</p>	
<p>Comm.Kit/outdoor wiring connections must be secured tightly and the cable should be routed properly so that there is no force pulling the cable from the connection terminals. Improper or loose connections can cause heat generation or fire.</p>	
<p>Do not touch, operate, or repair the product with wet hands. Holding the plug by hand when taking out. Otherwise there is risk of electric shock or fire.</p>	
<p>Do not turn on the breaker or power under condition that front panel, cabinet, top cover, control box cover are removed or opened. - Otherwise, it may cause fire, electric shock, explosion or death.</p>	

<p> CAUTION</p>	
<p>Be sure to earth the air conditioner with an earthing conductor connected to the earthing terminal.</p>	
<p>Do not tilt the unit when removing panels. Otherwise, the water inside the unit can spill and wet floor.</p>	
<p>Be sure to turn off power switch before connect or disconnect connector, or parts damage may be occurred.</p>	

1.2 Inspections after Repair

⚠ WARNING	
Check to see if the terminal block is not dirty or loose. If terminal block is dust or loose it can cause an electrical shock or fire.	
Do not use a joined power cable or extension cable, or share the same power outlet with other electrical appliances. otherwise, it can cause an electrical shock, excessive heat generation or fire.	
Do not insert hands or other objects through the air inlet or outlet while the product is operating. There are sharp and moving parts that could cause personal injury.	
Do not block the inlet or outlet of air flow. It may cause product failure	

⚠ CAUTION	
Check to see if the parts are mounted correctly and wires are connected. Improper installation and connections can cause an electric shock or an injury.	
Check the installation platform or frame has corroded. Corroded installation platform or frame can cause the unit to fall, resulting in injury.	
Be sure to check the earth wire is correctly connected.	
After the work has finished, be sure to do an insulation test to check the resistance is 2[Mohm] or more between the charge section and the non-charge metal section (Earth position). If the resistance value is low, a disaster such as a leak or electric shock is caused at user's side.	

Standards for Model

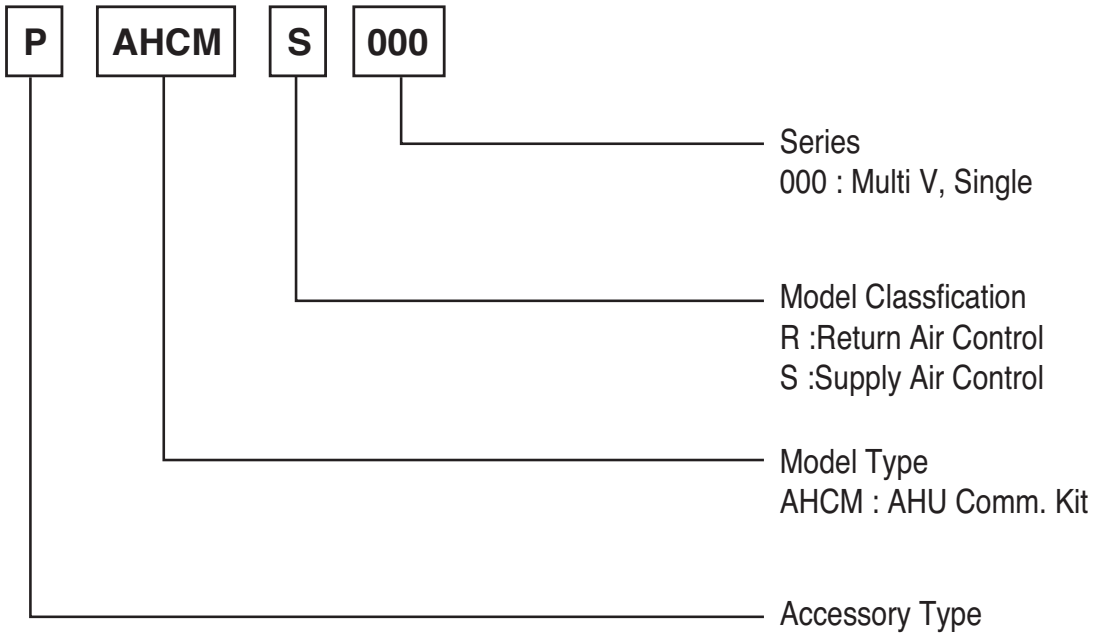

Functions & Accessory

1. Main Functions

Functions		Model	
		PAHCMS000	PAHCMR000
Input	Operation (on/off)	O	O
	Operation mode (cool/heat)	O	O
Output	Operation (on/off)	O	O
	Defrost signal	O	O
	Alarm signal	O	O
	Comp. status	O	X
ODU Capacity control		O	X
3rd Party DDC interlock		O	X

2. Accessory

Category	Functions	Model
Individual control	Remote controller	PQRCVSL0 / PQRCVSL0QW (Optional)

[Note]

• O: Applied, • X: Not applied

Accessory model name : Installed at field, ordered and purchased separately by the corresponding model name, supplied with separate package.

Wiring Diagram

Model : PAHCMR000

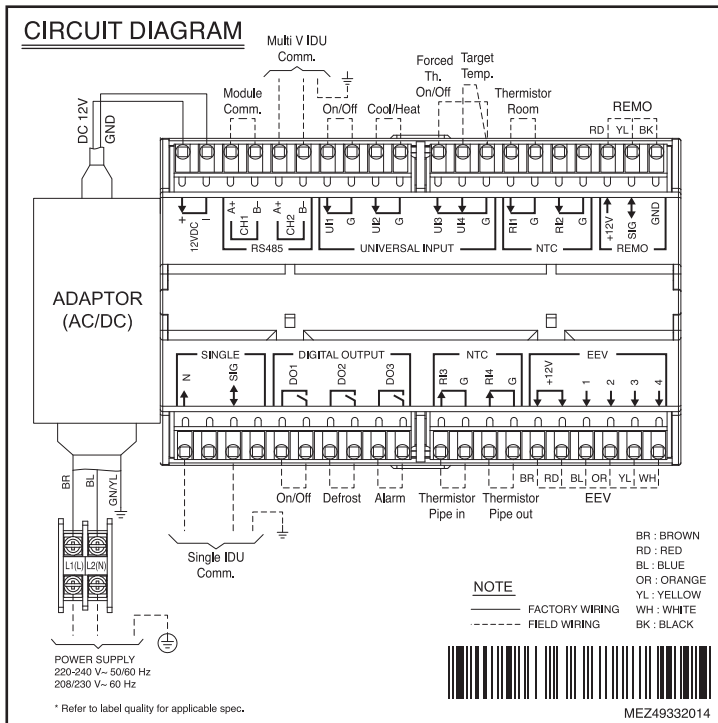

Model : PAHCMS000

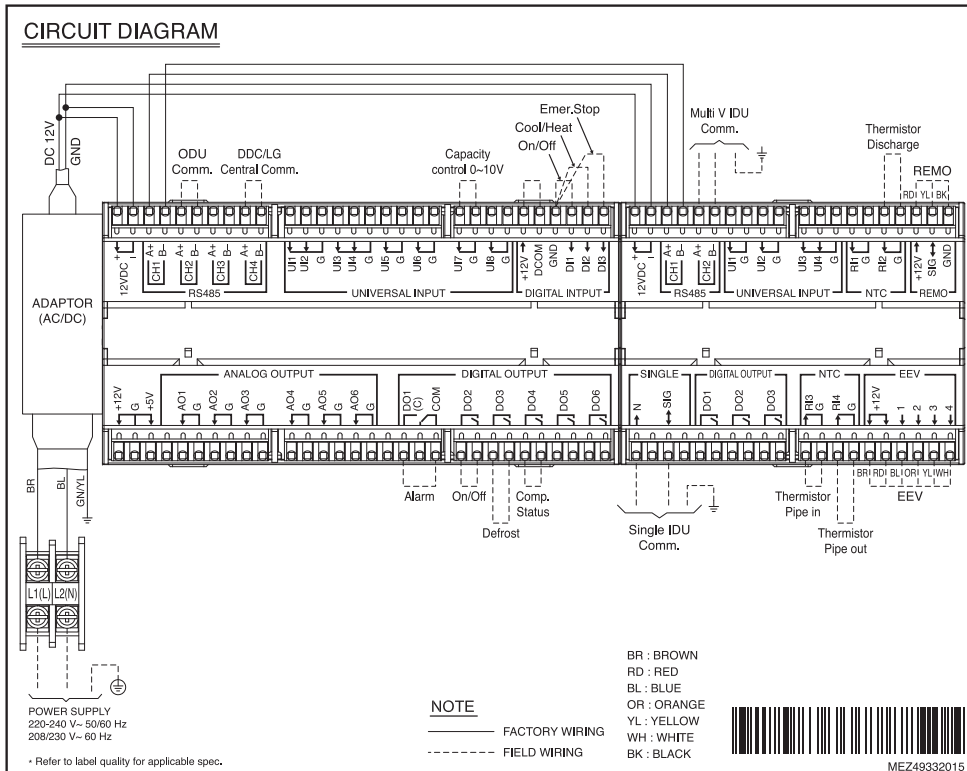

■ Main Module

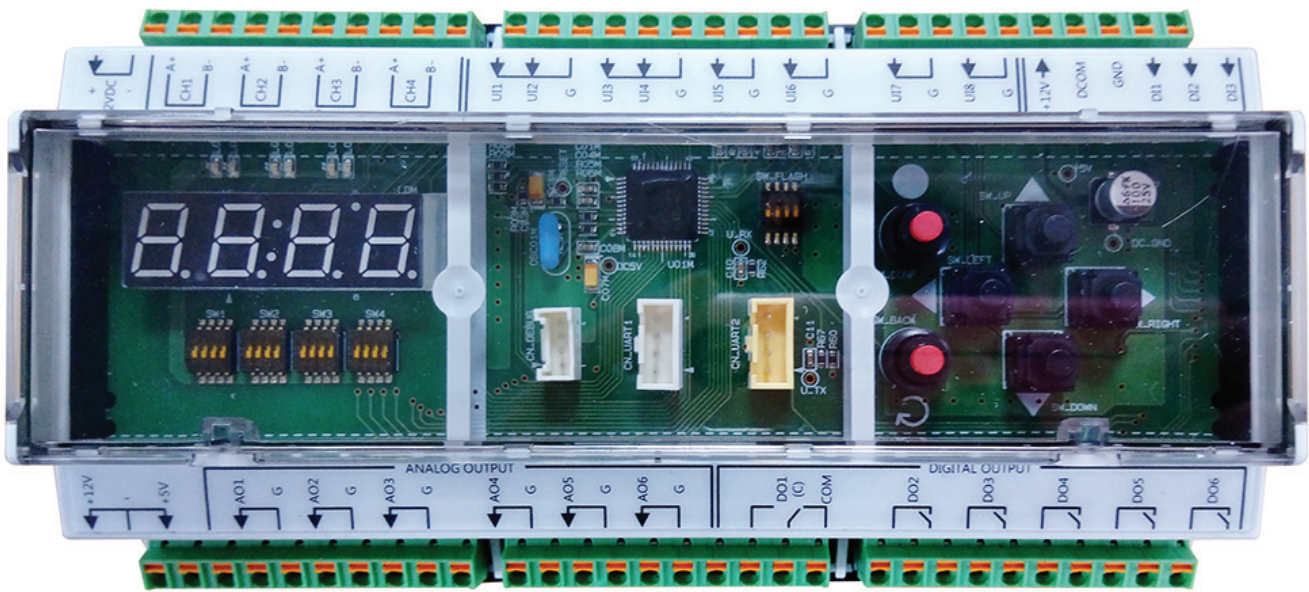

■ Main Module

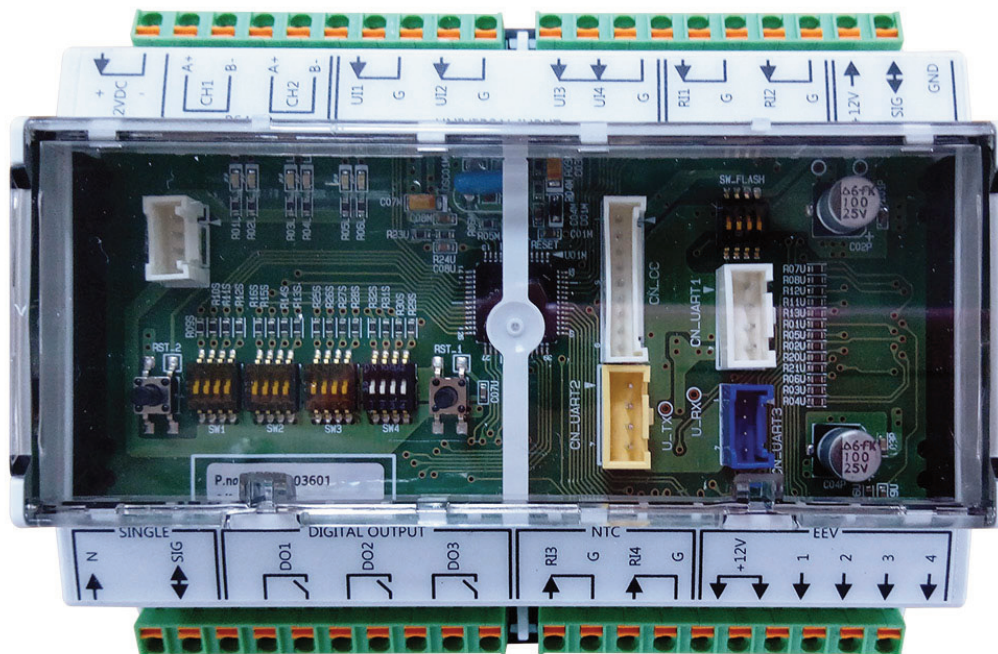

Disassembly Diagram (Deal Drawing)

Model : PAHCMR000

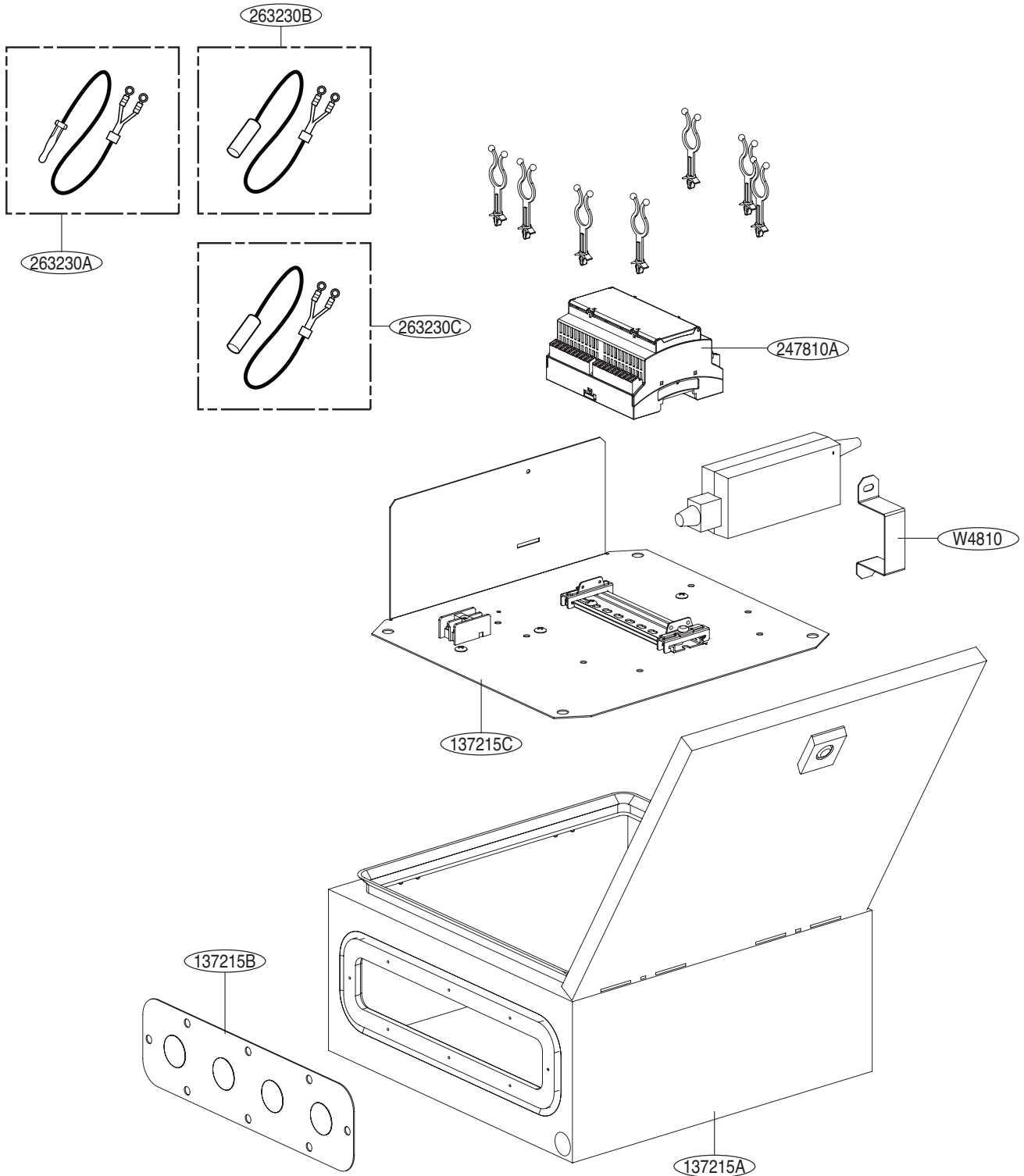

SVC Parts List

Location No.	Item	Part No.	Quantity(Volume/Amount)	SVC	Remarks
			PAHCMR000		
137215A	Panel Assembly,Control	AGL75873901	1	R	
137215B	Panel Assembly,Control	AGL75874301	1	R	
137215C	Panel Assembly,Control	AGL76255601	1	R	
W4810	Bracket	MAZ64606301	1	R	
247810A	Controller Assembly	ACM75139001	1	R	Comm. PCB
263230A	Thermistor Assembly,NTC	EBG62485901	1	R	
263230B	Thermistor Assembly,NTC	EBG62485902	1	R	
263230C	Thermistor Assembly,NTC	EBG62485903	1	R	

Model : PAHCMS000

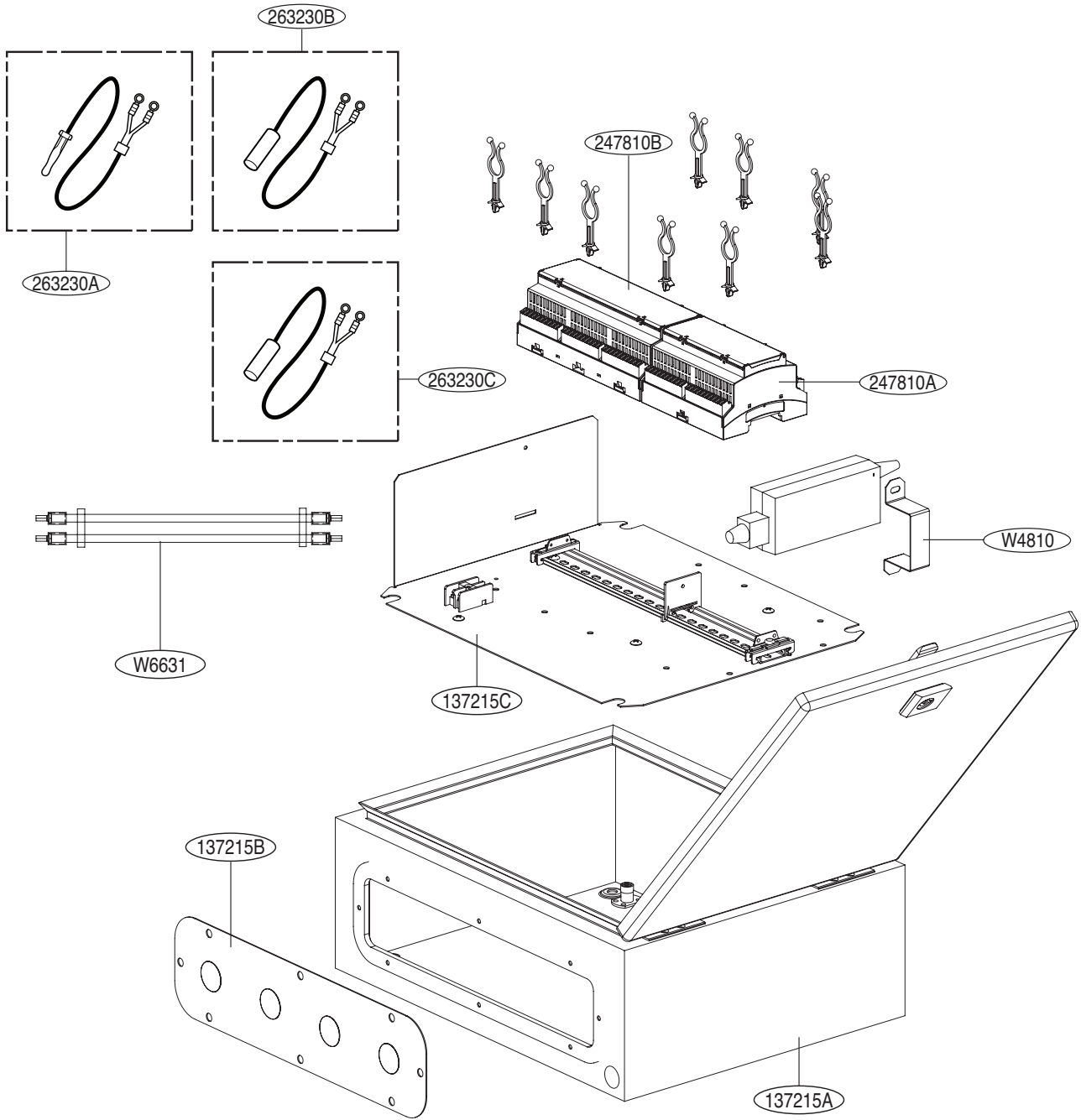

SVC Parts List

Location No.	Item	Part No.	Quantity(Volume/Amount)	SVC	Remarks
			PAHCMS000		
137215A	Panel Assembly,Control	AGL75874001	1	R	
137215B	Panel Assembly,Control	AGL75874302	1	R	
137215C	Panel Assembly,Control	AGL76255701	1	R	
W4810	Bracket	MAZ64606301	1	R	
247810A	Controller Assembly	ACM75139001	1	R	Comm. PCB
247810B	Controller Assembly	ACM75098801	1	R	Main PCB
263230A	Thermistor Assembly,NTC	EBG62485901	1	R	
263230B	Thermistor Assembly,NTC	EBG62485902	1	R	
263230C	Thermistor Assembly,NTC	EBG62485903	1	R	
W6631	Harness,Multi	EAD64109806	1	R	

Troubleshooting

1.1 Error Indicator (Comm.Kit)

Problem	Cause	Remedy
AHU Communication Kit does not work	No power supply	Check the electrical connection and voltage of the power supply.
	Wiring is wrong	Check the electrical connection of the Communication Kit (Refer to the circuit diagram of the Communication Kit)
	AHU Communication Kit is broken	Check the electrical and mechanical part.

Error Indicator

- This function indicates types of failure in self-diagnosis and occurrence of failure for air condition.
- Error mark is displayed on wired remote controller, and 7-segment LED of outdoor unit control board as shown in the table.
- If more than two troubles occur simultaneously, lower number of error code is first displayed.
- After error occurrence, if error is released, error LED is also released simultaneously.

[Error Code (Comm.Kit)]

Display Number		Error Item	Cause of Error
CH	01	Room Temperature	Temperature sensor disconnection or short circuit on Room or RA of AHU
CH	02	Pipe In Temperature sensor error	Temperature sensor disconnection or short circuit on pipe inlet of AHU
CH	03	Communication error between wired remote controller and Comm. Kit	No communication signal for more than 3 minutes from wired remote controller to the Comm. Kit
CH	05	Communication error between Comm. Kit and Outdoor Unit	No communication signal for 5 minutes continuously from Comm. Kit to Outdoor Unit
CH	06	Pipe Out Temperature sensor error	Temperature sensor disconnection or short circuit on pipe outlet of AHU

[Error Code (Outdoor Unit)]

⚠ CAUTION

- This page is about outdoor error code. It can vary depending on outdoor unit. For more information, please refer to the outdoor unit manual.

Display				Title	Cause of Error
Outdoor unit related error	2	1	1	Outdoor unit Inverter Compressor IPM Fault	Outdoor unit Inverter Compressor Drive IPM Fault
	2	2	1	Inverter Board Input Over Current(RMS) of Outdoor Unit	Outdoor unit Inverter Board Input Current excess (RMS)
	2	3	1	Outdoor unit Inverter Compressor DC link Low Voltage	DC charging is not performed at Outdoor unit after starting relay turn on.
	2	4	1	Outdoor unit High Pressure Switch	System is turned off by Outdoor unit high pressure switch.
	2	5	1	Outdoor unit Input Voltage High/ Low Voltage	Outdoor unit input voltage is over 487V or below 270V
	2	6	1	Outdoor unit Inverter Compressor Start Failure	The First Start Failure by Outdoor unit Inverter Compressor Abnormality
	2	8	1	Outdoor unit Inverter DC link High Voltage	System is turned off by Outdoor unit DC Voltage Over Charging
	2	9	1	Outdoor unit Inverter Compressor Over Current	Outdoor unit Inverter Compressor Fault OR Drive Fault
	3	0	1	Outdoor unit Constant Speed Compressor2 High Discharge Temperature	System is turned off by Outdoor Unit Constant Speed Compressor2 High Discharge Temperature
	3	2	1	Outdoor unit Inverter Compressor High Discharge Temperature	System is turned off by Outdoor unit Inverter Compressor High Discharge Temperature
	3	3	1	Outdoor unit Constant Speed Compressor1 High Discharge Temperature	System is turned off by Outdoor Unit Constant Speed Compressor1 High Discharge Temperature
	3	4	1	High Pressure of Outdoor Unit	System is turned off by excessive increase of high pressure of Outdoor unit
	3	5	1	Low Pressure of Outdoor unit	System is turned off by excessive decrease of low pressure of Outdoor unit
	3	6	1	Outdoor unit Low Condensing Ratio Limited	Outdoor unit stayed under low condensing limit for 3 minutes
	4	0	1	Outdoor unit Inverter Compressor CT Sensor Fault	Outdoor unit Inverter Compressor CT Sensor open or short
	4	1	1	Outdoor unit Inverter Compressor Discharge Temperature Sensor Fault	Outdoor unit Inverter Compressor Discharge Temperature Sensor open or short
	4	2	1	Outdoor unit Low Pressure Sensor Fault	Outdoor unit Low Pressure Sensor open or short
	4	3	1	Outdoor unit High Pressure Sensor Fault	Outdoor unit High Pressure Sensor open or short
	4	4	1	Outdoor unit Air Temperature Sensor Fault	Outdoor unit Air Temperature Sensor open or short
	4	5	1	Outdoor unit Heat Exchanger Temperature Sensor (Front side) Fault	Outdoor unit Heat Exchanger Temperature Sensor(Front side) open or short
4	6	1	Outdoor unit Suction Temperature Sensor Fault	Outdoor unit Suction Temperature Sensor open or short	

[Error Code (Outdoor Unit)]

⚠ CAUTION

- This page is about outdoor error code. It can vary depending on outdoor unit. For more information, please refer to the outdoor unit manual.

Display				Title	Cause of Error
Outdoor unit related error	4	7	1	Outdoor unit Constant Speed Compressor1 Discharge Temperature Sensor Fault	Outdoor unit Constant Speed Compressor1 Discharge Temperature Sensor open or short
	4	8	1	Outdoor unit Constant Speed Compressor2 Discharge Temperature Sensor Fault	Outdoor unit Constant Speed Compressor 2 Discharge Temperature Sensor open or short
	4	9	1	Outdoor unit Faulty IPM Temperature Sensor	Outdoor unit IPM Temperature Sensor short/open
	5	0	1	Omitting connection of R, S, T power of Outdoor unit	Omitting connection of outdoor unit
	5	1	1	Excessive capacity of indoor units	Excessive connection of indoor units compared to capacity of Outdoor Unit
	5	2	1	Transmission error : inverter PCB → Main PCB	Failing to receive inverter signal at main PCB of Outdoor unit
	5	3	1	Transmission error : indoor unit → main PCB of Outdoor Unit	Failing to receive indoor unit signal at main PCB of Outdoor Unit .
	5	4	1	Reverse connection of R, S, T power of Outdoor unit	Reverse connection or omitting connection of R, S, T power of Outdoor unit
	5	7	1	Outdoor unit Communication Error with Inverter Controller	Outdoor unit Controller part cannot receive inverter control signals (usually happens after on-boarding)
	6	0	1	Inverter PCB EEPROM Error of Outdoor Unit	Access Error of Inverter PCB of Outdoor unit
	6	7	1	Outdoor unit Fan Lock	Restriction of Outdoor unit
	6	9	1	Constant1 CT Sensor Error of Outdoor Unit	Constant1 CT Sensor open or short of Outdoor unit
	7	0	1	Constant2 CT Sensor Error of Outdoor Unit	Constant2 CT Sensor open or short of Outdoor unit
	7	3	1	Instant Over Current(Peak) of Outdoor unit PFC	Instant Over Current(Peak) of Outdoor unit PFC
	7	5	1	Outdoor unit Fan CT Sensor Error	Outdoor unit Fan CT Sensor open or short
	7	6	1	Outdoor unit Fan DC Link High Voltage Error	Outdoor unit Fan DC Link High Voltage Error
	7	7	1	Outdoor unit Fan Over Current Error	Outdoor unit Fan Current is over 5A
	7	9	1	Outdoor unit Fan Start Failure Error	Outdoor unit Fan First Position Sensing Failure
8	6	1	Outdoor unit Main PCB EEPROM Error	Communication Fail Between Outdoor unit Main MICOM and EEPROM or omitting EEPROM	
8	7	1	Outdoor unit Fan PCB EEPROM Error	Communication Fail Between Outdoor unit Fan MICOM and EEPROM or omitting EEPROM	

[Error Code (Outdoor Unit)]

⚠ CAUTION

- This page is about outdoor error code. It can vary depending on outdoor unit. For more information, please refer to the outdoor unit manual.

Display					Title	Cause of Error
Outdoor unit related error	1	0	4	1	Communication Error Between Outdoor unit and Other Outdoor Unit	Failing to receive Slave Unit signal at main PCB of Outdoor unit
	1	0	5	1	Outdoor unit Fan PCB Communication Error	Failing to receive fan signal at main PCB of master unit.
	1	0	6	1	Outdoor unit FAN IPM Fault Error	Instant Over Current at Outdoor unit Fan IPM
	1	0	7	1	Outdoor unit Fan DC Link Low Voltage Error	Outdoor unit Fan DC Link Input Voltage is under 380V
	1	1	3	1	Outdoor unit Liquid pipe Temperature Sensor Error	Liquid pipe temperature sensor of Outdoor unit is open or short
	1	1	5	1	Outdoor unit Subcooling Outlet Temperature Sensor Error	Outdoor unit Subcooling Outlet Temperature Sensor open or short
	1	5	1	1	Failure of operation mode conversion at Outdoor Unit	Pressure unbalance between Outdoor Units
	1	7	3	1	Outdoor unit Constant Speed Compressor Fault	Comp locking, Check Valve leakage, comp dielectric break down at Outdoor Unit
	1	7	4	1	Outdoor unit rated speed 2 condenser over-current	Outdoor unit rated speed 2 condenser burned / locked or fault by over-current
	1	9	0	1	Excessive increase of outdoor unit Inverter PCB Heat sink Temperature	Outdoor unit Inverter PCB Heat sink temperature is over 95°C
	1	9	1	1	Outdoor unit Inverter PCB Heat sink Temperature sensor error	Outdoor unit Inverter PCB Heat sink temperature sensor open or short
	1	9	3	1	Excessive increase of Outdoor unit Fan PCB Heat Sink Temperature	Outdoor unit Fan Inverter PCB Temperature is Over 95°C
	1	9	4	1	Outdoor unit Fan PCB Heat Sink Temperature Sensor Error	Outdoor unit Fan PCB Heat Sink Temperature Sensor open or short

