

INSTALLATION MANUAL AIR CONDITIONER

- Please read this installation manual completely before installing the product.
- Installation work must be performed in accordance with the national wiring standards by authorized personnel only.
- Please retain this installation manual for future reference after reading it thoroughly.

TYPE : **THERMAV**
(Sanitary Water Tank Kit)

MODEL : PHLTB

P/NO : MFL6522201

www.lg.com

Connecting Sanitary Water Tank

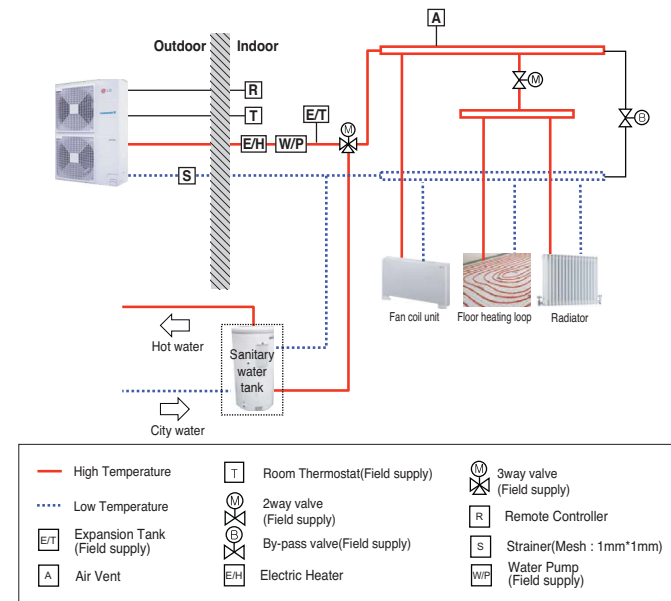

- Note:**
- Sanitary water tank
 - It should be equipped with internal electric heater to generate sufficient heat energy in very cold season.
 - 3way valve
 - Refer to the installation manual of **THERMAV** to install the 3way valve.

THERMAV supports following 3way valve.

Type	Power	Operating Mode	Supported
SPDT 3-wire (1)	1~230 V	Selecting "Flow A" between "Flow A" and "Flow B" (2)	Yes
		Selecting "Flow B" between "Flow A" and "Flow B" (3)	Yes

(1) : SPDT = Single Pole Double Throw. Three wires consist of Live1 (for selecting Flow A), Live 2 (for selecting Flow B), and Neutral (for common).

(2) : Flow A means 'water flow from the unit to under floor water circuit.'

(3) : Flow B means 'water flow from the unit to sanitary water tank.'

Safety Precautions

- To prevent injury to the user or other people and property damage, the following instructions must be followed.
- Be sure to read before installing the unit.
 - Be sure to observe the cautions specified here as they include important items related to safety.
 - Incorrect operation due to ignoring instruction will cause harm or damage. The seriousness is classified by the following indications.

⚠ WARNING This symbol indicates the possibility of death or serious injury.

⚠ CAUTION This symbol indicates the possibility of injury or damage to properties only.

⚠ WARNING

- | | | |
|---|--|--|
| <p>Do not use a defective or underrated circuit breaker. Use this appliance on a dedicated circuit.</p> <ul style="list-style-type: none"> • There is risk of fire or electric shock. | <p>For electrical work, contact the dealer, seller, a qualified electrician, or an Authorized Service Center.</p> <ul style="list-style-type: none"> • There is risk of fire or electric shock. | <p>Always ground the unit.</p> <ul style="list-style-type: none"> • There is risk of fire or electric shock. |
| <p>Install the panel and the cover of control box securely.</p> <ul style="list-style-type: none"> • There is risk of fire or electric shock. | <p>Always install a dedicated circuit and breaker.</p> <ul style="list-style-type: none"> • Improper wiring or installation may cause fire or electric shock. | <p>Use the correctly rated breaker or fuse.</p> <ul style="list-style-type: none"> • There is risk of fire or electric. |
| <p>Do not modify or extend the power cable.</p> <ul style="list-style-type: none"> • There is risk of fire or electric shock. | <p>Do not install, remove, or reinstall the unit by yourself (customer).</p> <ul style="list-style-type: none"> • If the base collapses, the unit could fall with its weight, causing explosion, or injury. | <p>Be cautious when unpacking and installing the unit.</p> <ul style="list-style-type: none"> • Sharp edges could cause injury. Especially careful on the unit edges and the fins on the heat exchanger. |
| <p>For antifreeze, always contact the dealer or an authorized service center.</p> <ul style="list-style-type: none"> • Almost the antifreeze is a toxic product. | <p>Be sure the installation area does not deteriorate with age.</p> <ul style="list-style-type: none"> • If the base collapses, the unit could fall with its weight, causing property damage, unit failure, and personal injury. | |
| <p>For installation, always contact the dealer or an Authorized Service Center.</p> <ul style="list-style-type: none"> • There is risk of fire, electric shock, explosion, or injury. | <p>Do not install the unit on a defective installation stand.</p> <ul style="list-style-type: none"> • It may cause injury, accident, or damage to the unit. | |

⚠ CAUTION

- | | |
|--|---|
| <p>Keep level even when installing the unit.</p> <ul style="list-style-type: none"> • To avoid vibration or water leakage. | <p>Use two or more people to lift and transport the unit.</p> <ul style="list-style-type: none"> • Avoid personal injury. |
|--|---|

Parts

- 1 Sensor (Thermistor)
- 2 Water tank kit
- 3 Installation Manual

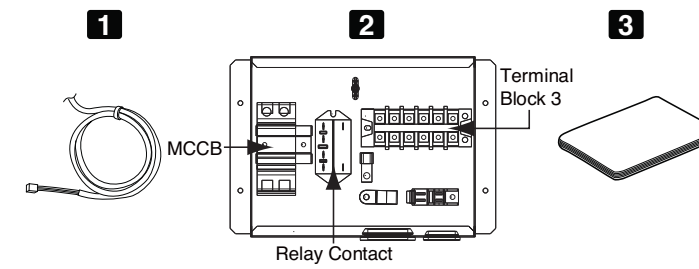

Wiring Diagram

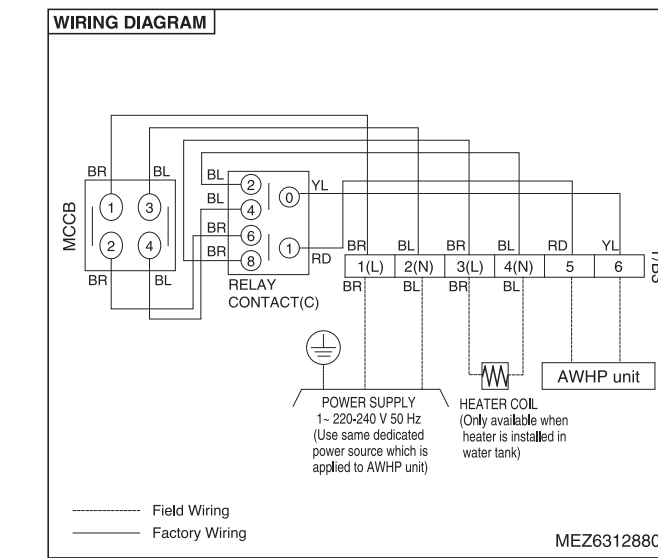

Installation Method

To establish sanitary water circuit, 3way valve and sanitary water tank kit is required.

How to Install Sanitary Water Tank Kit

Follow below procedures Step 1 ~ Step 5.

- Step 1.** Uncover the water tank kit and locate it on the wall.
- Step 2.** Connect the water tank kit to the main power like the below figure 2.
- Step 3.** Connect the water tank kit to the Main PCB Assembly1 like the below figure 2.
- Step 4.** Connect power cord of sanitary tank heater. It is located inside of the tank. Refer to the next page for more information.
- Step 5.** Find sanitary water tank sensor. Plug it to 'CN_TH4' (Red Connector) of the main PCB assembly 1. The sensor should be mounted correctly to the sensor hole of sanitary water tank.

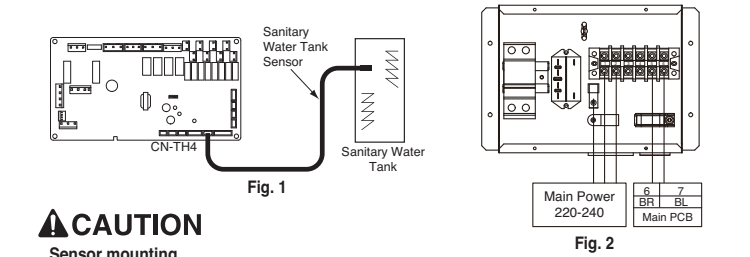

⚠ CAUTION

- Sensor mounting**
- Insert sensor into sensor socket and bolt it tightly.

How to Wire Sanitary Water Tank Heater

- Step 1.** Uncover heater cover of the sanitary water tank. Heater is located inside of the tank.
- Step 2.** Find terminal block in the water tank kit and connect wires as below. Wires are field-supplied item.

(L) : Live signal from Water Tank Kit to Heater
(N) : Neutral signal from Water Tank Kit to Heater

⚠ WARNING

- Wire specification**
- Cross-sectional area of the wire should be over 5mm².
 - You should use the shield wire for the signal wire in terminal block 5,6 not to make the electric noise.
- Adjusting thermostat temperature**
- To guarantee proper operation, it is recommended to set temperature of thermostat to maximum temperature (symbol ⊕ at the figure 3).

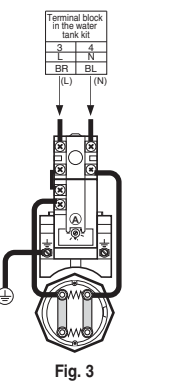

⚠ WARNING

- Installing recirculation pump**
- When **THERMAV** is used with sanitary water tank, it is STRONGLY recommended to install recirculation pump to prevent flooding out cold water at the end of hot water supply and to stabilize the water temperature inside the sanitary water tank.
- The recirculation pump should be operated when sanitary water demand is not required. Therefore, external time scheduler to determine when the recirculation pump should turn on and turn off is required.
 - The operating duration time of the recirculation pump is calculated as follow :
Duration time [minute] = (k²V)/R
k : 1.2 ~ 1.5 is recommended. (If distance between pump and tank is far, then choose high number.)
V : Volume of sanitary water tank [liter]
R : Water flow rate of pump [liter per minute], which is determined by pump performance curve.
 - The pump operating start time should be prior to the sanitary water demand.

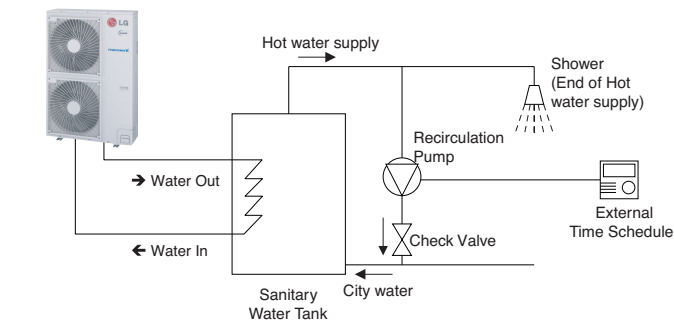

DIP Switch Setting

⚠ CAUTION

- Turn off electric power supply before setting DIP switch.**
- Whenever adjusting DIP switch, turn off electric power supply to avoid electric shock.

General Information

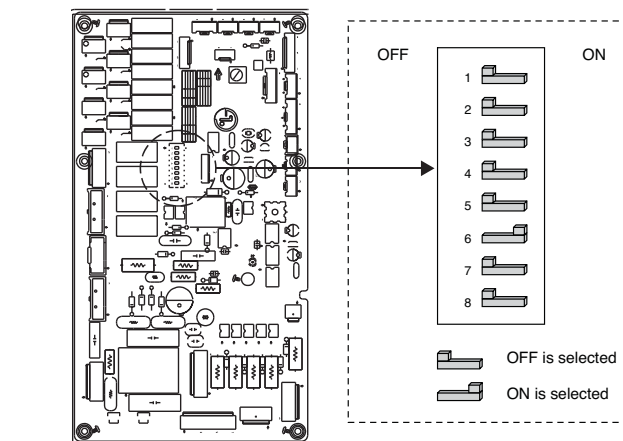

Description	Setting	Default	
Accessory installation information.	2 3	Unit only	
	2 3	Unit + Sanitary water tank is installed.	2
	2 3	Unit + Sanitary water tank + Solar thermal system is installed.	3