

INSTALLATION MANUAL

V-NET

- Please read this installation manual completely before installing the product.
- Installation work must be performed in accordance with the national wiring standards by authorized personnel only.
- Please retain this installation manual for future reference after reading it thoroughly.

TYPE : Simple Dry contact

MODEL : PDRYCB100



P/NO : MFL67708304

www.lg.com

TABLE OF CONTENTS

■ Safety Precautions	3
■ Overview	6
■ Part Description	8
■ Installation Method	9
Installation	9
■ Installation Guide	11
Step1	11
Step2	12
■ Administrator Guide	13

Safety Precautions



To prevent injury to the user or other people and property damage, the following instructions must be followed.

- Incorrect operation due to ignoring instruction will cause harm or damage. The seriousness is classified by the following indications.

⚠ WARNING This symbol indicates the possibility of death or serious injury.

⚠ CAUTION This symbol indicates the possibility of injury or damage.

- Meanings of symbols used in this manual are as shown below.

	Be sure not to do.
	Be sure to follow the instruction.

⚠ WARNING

■ Installation

Don't touch with the hands while the power is on.

- Cause fire, electric shock, explosion or injury.

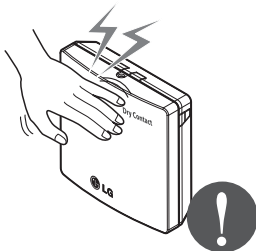

Product installation must be referred to a service center or installation shop.

- Cause fire, electric shock, explosion or injury.

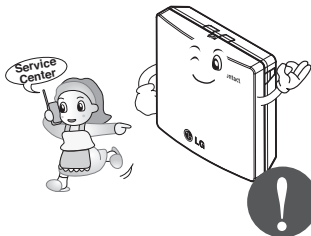

Request installation from installation shop or service center when reinstalling the product.

- Cause fire, electric shock, explosion or injury.



Do not install the product in the place where rain can get to the product.

- Cause product failure

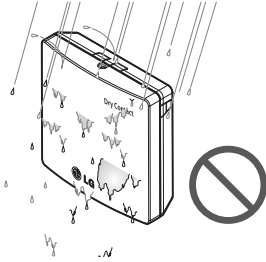

Do not install the unit in humid locations.

- Cause product failure

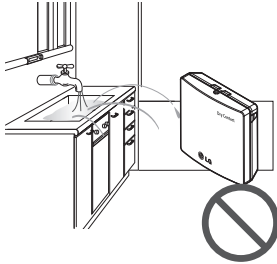

Do not put the product closer to fire.

- Cause fire

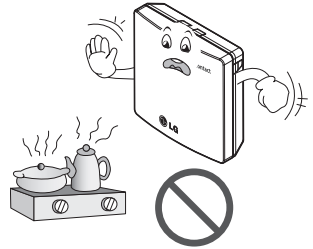

Do not install in a place that cannot withstand the weight of the product.

- The product may get damaged or may break.

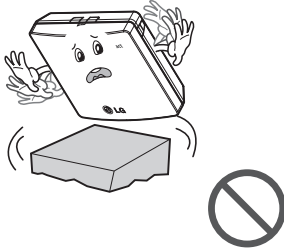

Do not install the product to a place that generates oil, steam, salt, sulfuric gas, etc.

- Cause the product's deformation or failure.

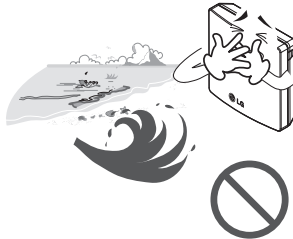

Use standardized Product.

- Cause product failure

Standardized product



■ Operation

Do not change or extend power lines arbitrarily.

- Cause fire or electric shock.

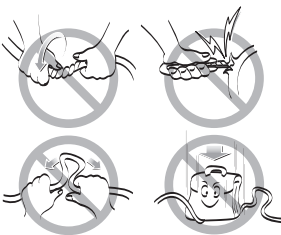

Do not give a shock to the product.

- If you give a shock to the product, it may cause the product's failure.

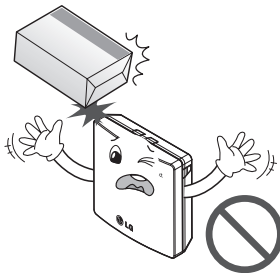

Do not use a heater near the power line.

- Cause fire or electric shock.

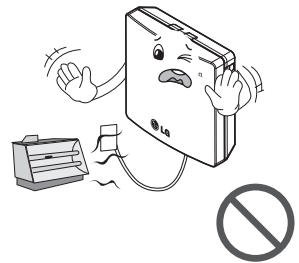

Do not spill water inside of the product.

- Cause electric shock or breakdown.

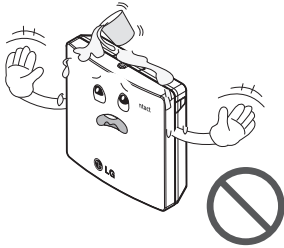

If the product has been in-undated, you must refer to a service center or installation shop.

- It can cause a fire.



Children and elderly use the product under the guardian's supervision.

- Cause accidents and product failures.

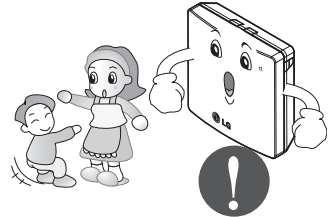

Do not use for special purpose / place such as conserving flora and fauna, precision instruments, art.

- Otherwise, it can cause property damage.

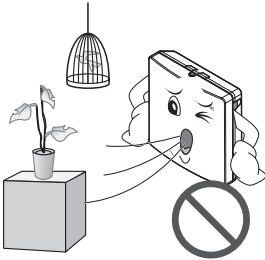

Remove the power plug when cleaning.

- Cause fire or electric shock.

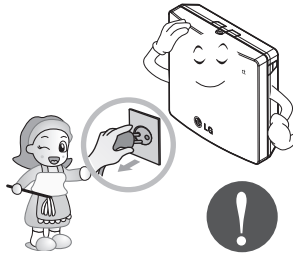

Do not place heavy objects on the power line.

- Cause fire or electric shock.

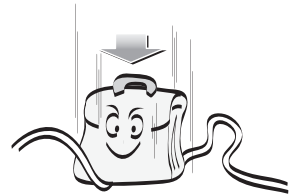

Do not disassemble, repair, or modify the product.

- Cause fire or electric shock.

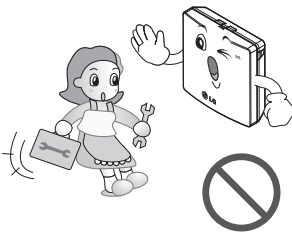

Do not touch with wet hands.

- Cause fire or electric shock.



Overview

LG Dry Contact is a solution for automatic control of air conditioning system at the owner's behest.

In simple words, it's a switch which can be used to turn the unit On/Off after getting the signal from external sources like key-in lock, door or window switch etc specially used in Hotel rooms.

It's a small PCB that either can be fit inside the control box of Indoor unit or can be outside the unit in a plastic case if there is no sufficient space inside the Indoor unit.

Apart from simple installation, it can also be linked to Central Controller via Indoor unit PI485 pcb. For this, all connecting wires & an additional small pcb for looping is also provided along with Dry Contact.

Dry Contact can be used in two ways.

1. It can be used to actually turn On/Off the system on receiving the signal from the source.
In this case, user doesn't need to use remote controller anymore to turn On/Off the system.
However all the further settings like temperature, fan speed, mode etc can be done through remote controller only.
2. Other way is almost similar as above but in this case, after getting the On signal from the external source, user has to turn On the system from remote controller only. Dry contact just activates the system.
However system can be turned Off directly from the external source. So only On mode is different here.

So in both of above conditions, system can't be operated without signal from external source which prevents unnecessary use of system & facilitates its operation only when its required.

These settings can be selected from the remote controller whose details have been explained in the later part of this manual

So depending upon the requirement, Dry Contact offers a variety of applications to suit the customer's requirement in the best possible way.

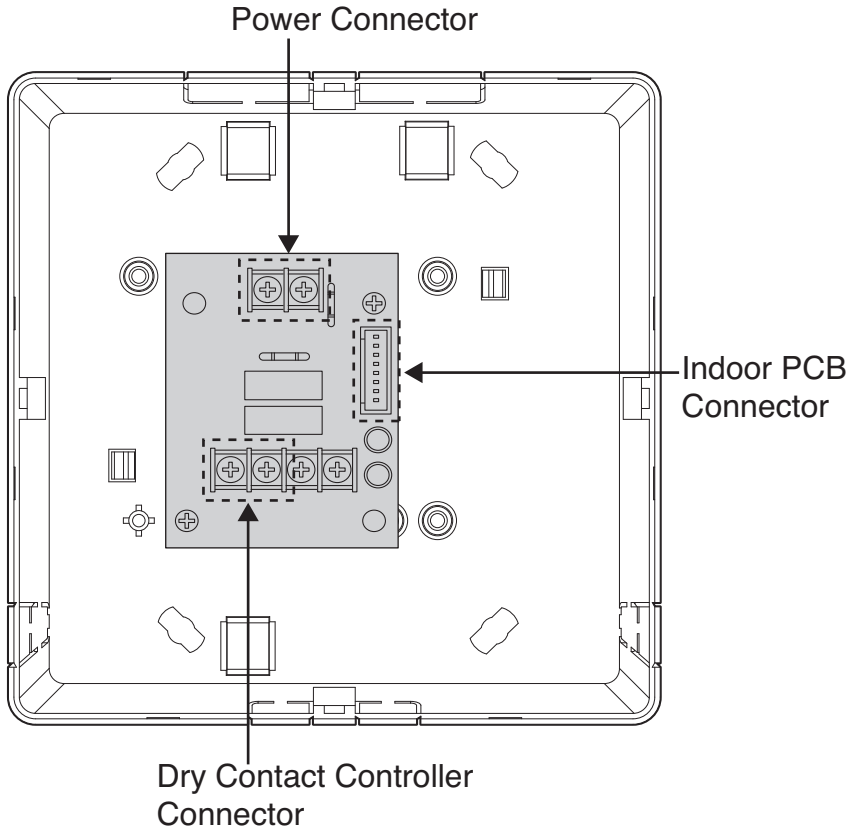

Part Description

PDRYCB100 (PCB + Case)

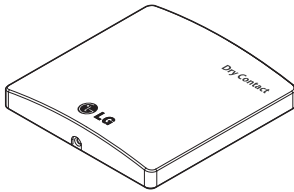

Front Case

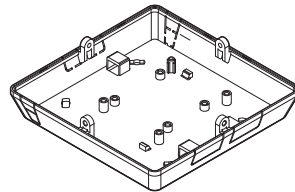

Rear Case

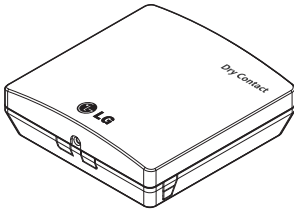

ISO View

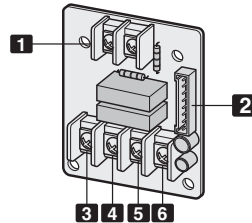

PCB

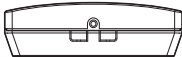

Side

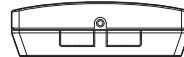

Side



Cable(1 EA)

(For Connecting with indoor unit)

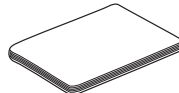

Installation Manual

* Others :

Screw 4 EA(For installation)

Clamp 4 EA(For installation)



Cable 1 EA

(For Central Controller)

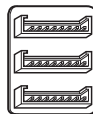

Connecting PCB:

6871A30056A

- 1** CN-POWER : 24 V~ Connector
- 2** CN-CC : Indoor PCB Connector
- 3** CN_DRY(L): DRY CONTROLLER Connector
- 4** CN_DRY(SIG): DRY CONTROLLER Connector
- 5** CN_DRY(ERROR CHECK): ERROR Check Display Connector
- 6** CN_DRY(OPER STATE): Operation Display Connector

Installation Method

Installation

- 1) Loosen and remove two screws that secure the product.

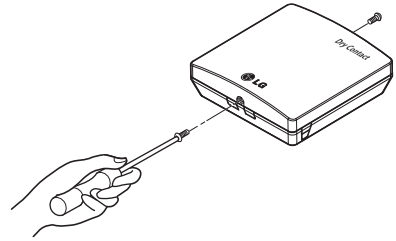

- 2) Position the rear case to the direction towards to the connector for convenient cable arrangement.

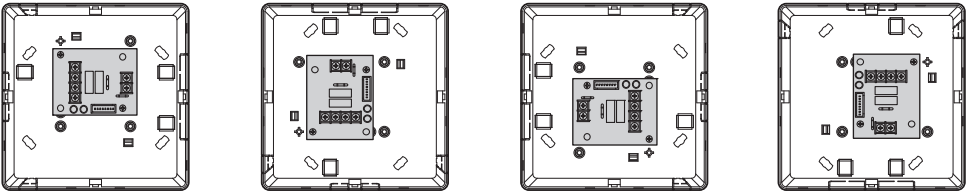

- 3) Secure the rear case on the installation place using the supplied fixing screws.

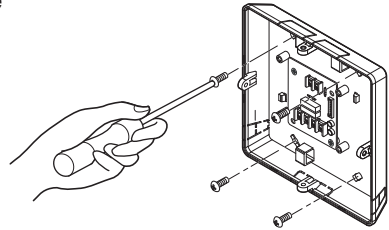

- 4) Remove knock out shapes on the rear case (4-sided) according to the connector's size and direction.

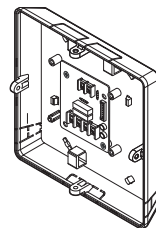

- 5) Connect the connection wires properly according to the connection method. (Refer to the instruction and set-up description)
- 6) Set the switch according to the setting method. (Refer to the instruction and set-up description)
- 7) Tighten the fixing screws on the top and bottom of the case.

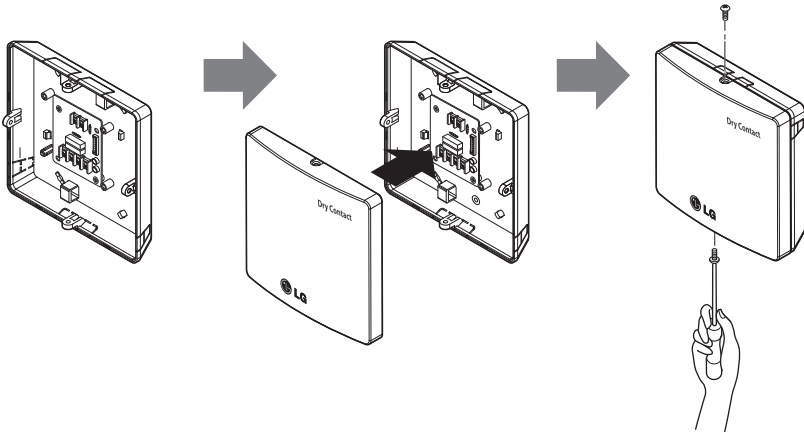

⚠ CAUTION

1. Install the product on flat surface and install anchoring screws at more than 2 places. Otherwise the central controller may not be anchored properly.
2. Do not tighten anchoring screws too tightly. It may cause deformation of the case.
3. Do not deform the case at random. It may cause malfunction of the central controller.

Installation Guide

Step 1

Connect CN-CC with Indoor PCB by the cable(provided)

- Connection of Dry contact only

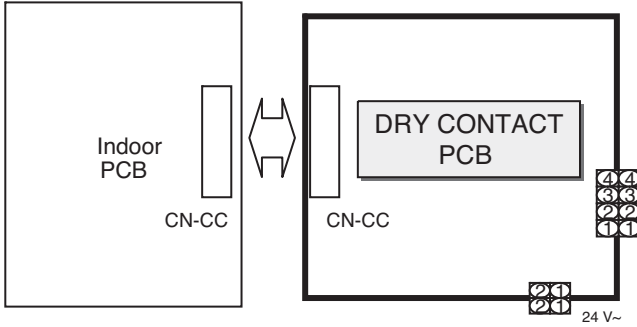

- Connection of Dry contact & LG Central Controller in case of single constant models.

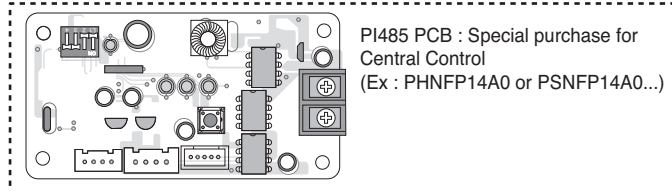
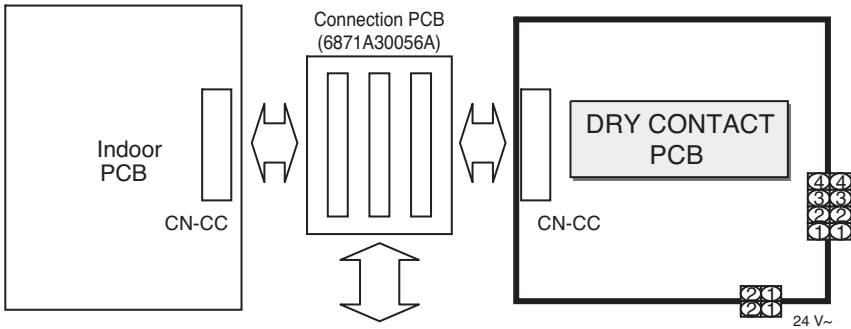

* Single Only

- When you install single product this PCB have to add.

Step 2

Connect CN_DRY with Control Unit .
(Fix SUB PCB into the proper location.)

- To apply power source through PCB

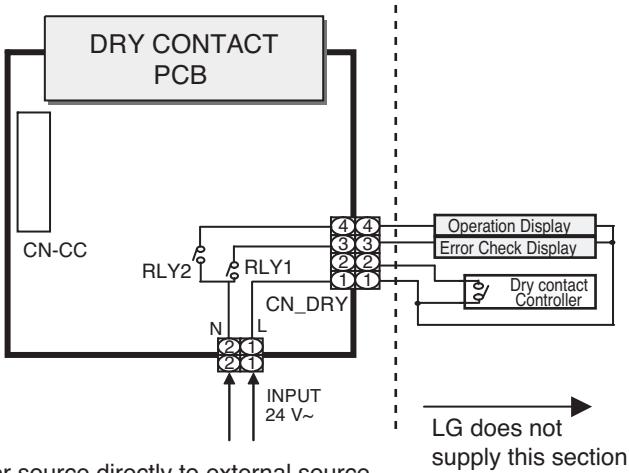

- To apply power source directly to external source

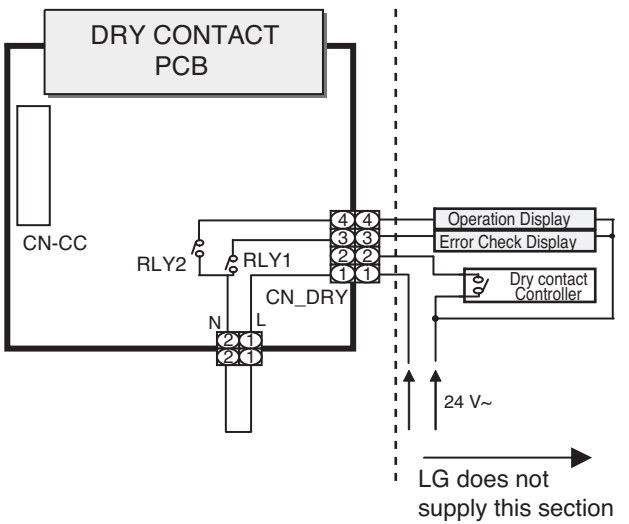

Administrator Guide

* Function

It gives selection whether to turn ON the unit directly or not from the external source. The selection can be made by pressing CANCEL button of the wireless remote controller 3 times within 3 minutes of resetting the unit with facing it towards the unit. (This function availability depends on indoor unit model)

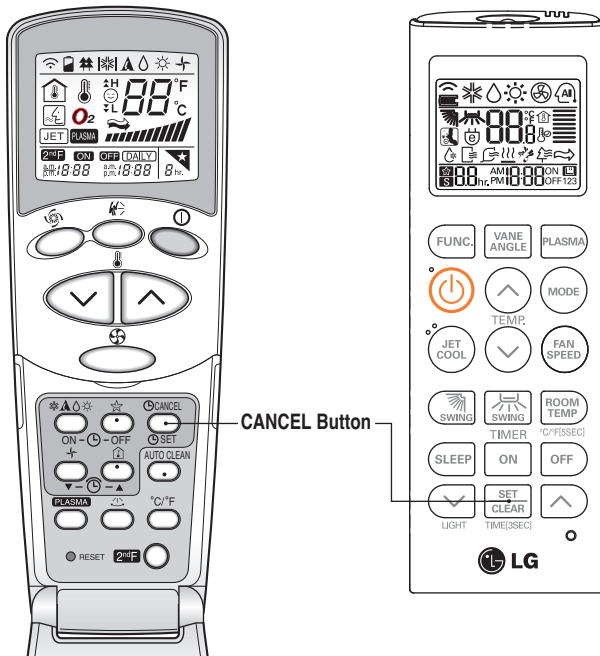

1. To turn ON the unit directly from the external source
2. Not to turn ON the unit directly from the external source.
Only to activate the system.



If the power gives out, the Air conditioner may be run to before state after power returns because Air conditioner's function of interruption of electric power compensation.

